

### Features

- Safeguard® slip-resistant finish for added safety.
- Single threshold for alcove installation with three tile-in flanges.
- Recessed drain (can be used with K-9155 or K-9156 drain cover).
- Right center drain.
- Ideal size for remodel installations into a 5-foot alcove with a shower door.
- Rim size optimized for water containment and aesthetics.

### Material

- KOHLER® enameled cast iron.

### Required Products/Accessories

K-9155 Drain Cover

or

K-9156 Drain Cover

### Recommended Products/Accessories

K-9132 Shower Drain



### Codes/Standards

ASME A112.19.1/CSA B45.2







ASTM F462

### KOHLER® Enameled Cast Iron Bath and Shower Base Lifetime Limited Warranty

See website for detailed warranty information.

### Available Colors/Finishes

*Color tiles intended for reference only.*

Color	Code	Description
	0	White
	96	Biscuit
	47	Almond
	NY	Dune
	95	Ice™ Grey
	G9	Sandbar

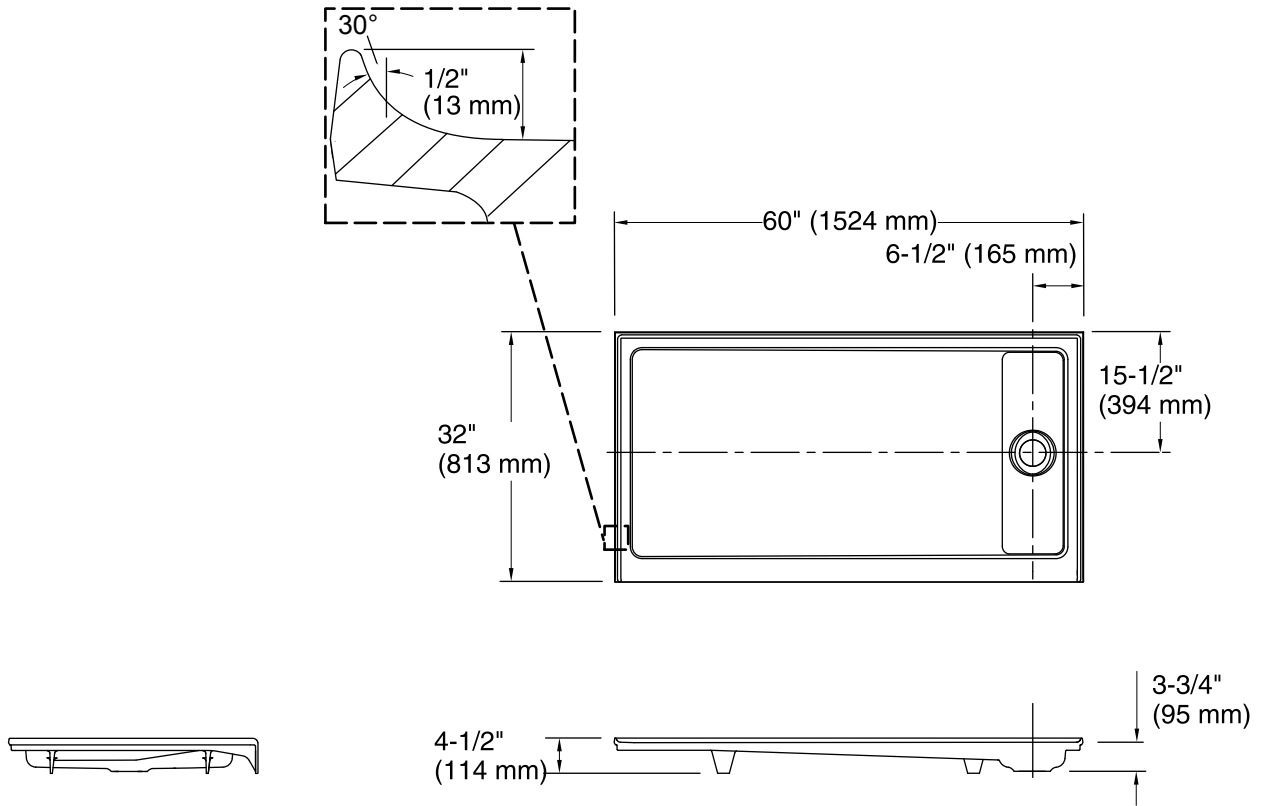

#### Technical Information

All product dimensions are nominal.

Installation: Three-wall alcove

Drain location: Right

Weight: 230 lbs (104.3 kg)

#### Notes

Measure your actual product for rough-in details. Install this product according to the installation instructions.

The dimensions are applicable for this product only and should not be used to fabricate substitute bases for shower enclosures.

The K-1657/K-1663 or K-1708/K-1647-PC steam generator/control kit are designed for use with this product. Kohler Co. shall not be responsible for problems encountered due to the installation and use of other manufacturer's steam generators.