







## CARE AND MAINTENANCE

Leather surfaces on Safavieh Furniture should be dusted regularly with a dry or slightly damp soft cloth. Avoid using saddle soap or other cleaners. Leather desks and tabletops have a lacquer coating, therefore they can be lightly waxed. Suede surfaces should only be cleaned with a dry, stiff brush. Exposure to liquid spills should be avoided since suede cannot be washed or cleaned like leather. 100% Safavieh Bicast Leather.

## NOTICE

- \* Please make sure that you have all parts indicated before you begin assembly of this item
- \* This item should be assembled on a soft surface to prevent scratching the finish during assembly
- \* This item may require periodic tightening

## Part List and Hardware List

PIECE	DESCRIPTION	PICTURE	QUANTITY
A	SCREW		4X
B	GASLIFT		1X
C	SUPPORT		1X
D	BASE		1X
E	SEAT		1X
F	ALLEN KEY		1X
G	RING		1X

 **SAFAVIEH**  
FURNITURE

Model# FOX7510

Product Dimensions: 15.2" W x 15.2" D x 25.2-33.9" H

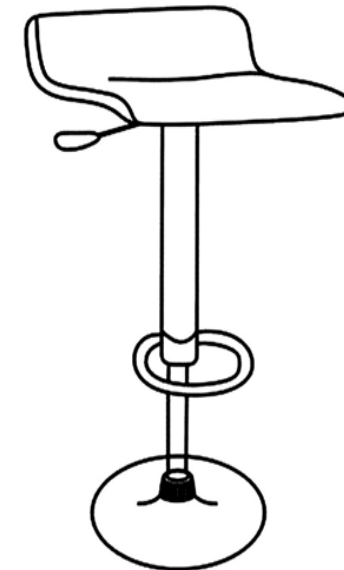

## PREPARATION

Before beginning assembly of product, make sure all parts are present. Compare parts with package contents list and hardware contents list.

If any part is missing or damaged, do not attempt to assemble the product.

Estimated Assembly Time: 10 minutes.

Tools Required for Assembly (included): Allen Key

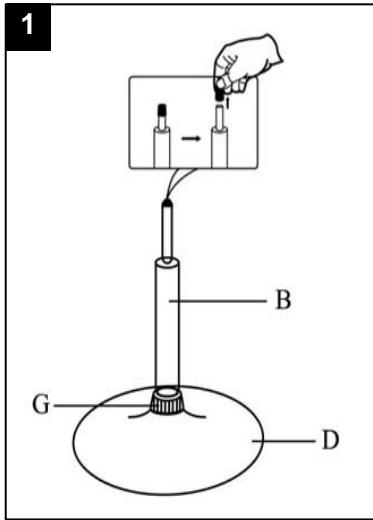

**Step 1**  
Before beginning of assemble, pls take off the gaslift cup, then put the gaslift(B) and ring (G) in the top of base(D)

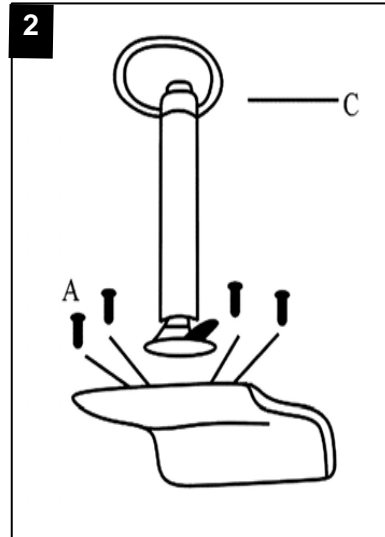

**Step 2**  
Attach the support(C) with four screws (A) in the seat(E)

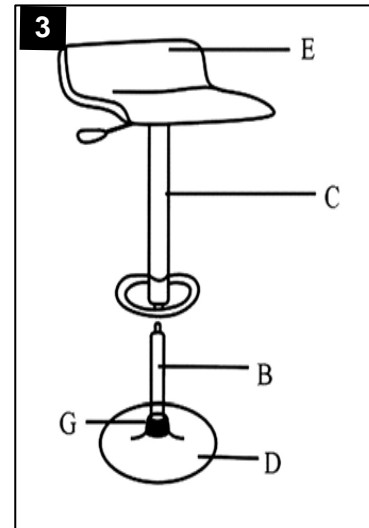

**Step 3**  
Put the support(C) in the gaslift (D)

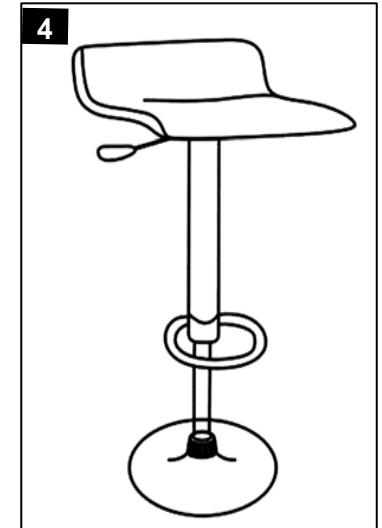

**Step 4**  
Finished the whole assemble