

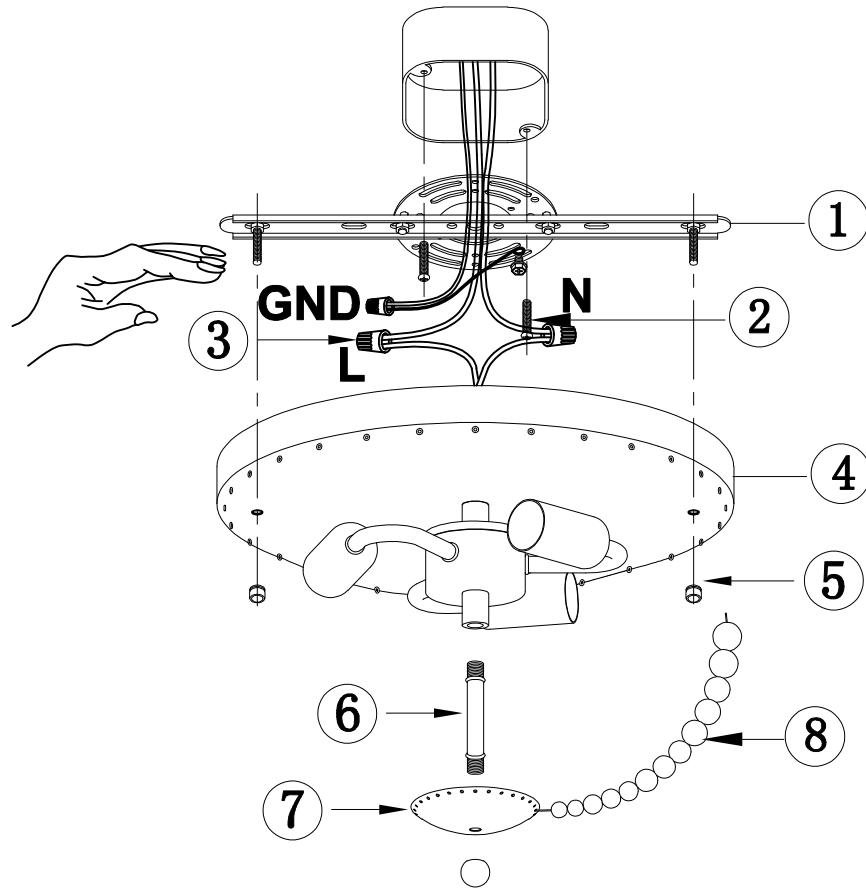





ITEM NO.: SYB1003WO-LT

FIXTURE ASSEMBLY STEPS:

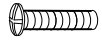

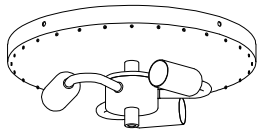
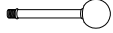
DESCRIPTION	PICTURE	CODE	QTY
Mounting Plate		1/5	1 SET
Mounting Box Screw		2	2 PCS
P3 Wiring Cap		3	3 PCS
Lamp body		4	1 SET
Threaded pipe		6	1 PCS
Downswing		7	1 PCS
Wooden beads		8	29PCS

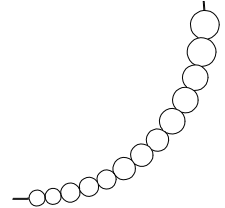
WARNING - if any Special Control Devices are used with this Fixture, Follow the instructions Carefully to assure full compliance With N. E. C. requirements. if there are any questions, contact a Qualified Electrical Contractor.

CAUTION - All glass is fragile, use care when handling Glass component(s) and or Lamp(s).

WARNING - This product contains chemicals known to the State of California to cause cancer, birth defects and/or other reproductive harm. Thoroughly wash hands after installing, handling, cleaning, or otherwise touching this product

CANOPY MOUNTING & WIRE CONNECTION ASSEMBLY STEPS:

Attach (N), (P) to achieve overall desired length.

Una (N), (P) para lograr la longitud deseada.

Joignez (N), (P) pour obtenir la Longueur voulue.

FIXTURE ASSEMBLY STEPS:

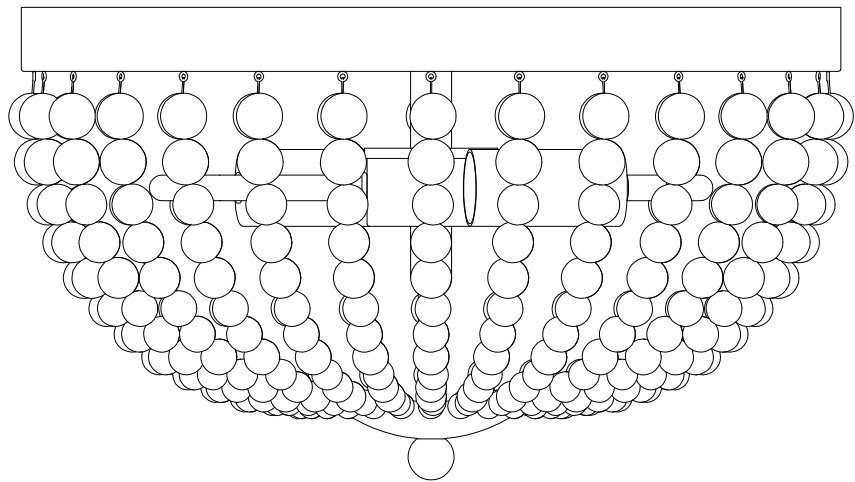
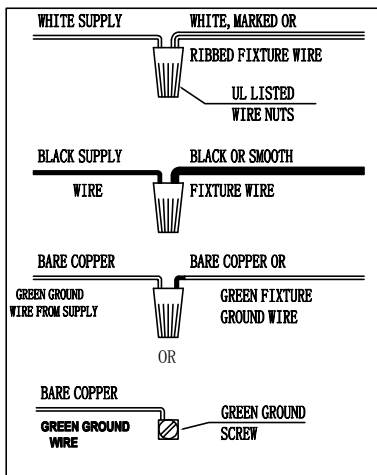

110-120V / 60Hz

E12 3*MAX 60W TYPE B

(Do not contain light bulb)

ITEM NO. : SYB1003WO-LT

1. AC110~120V, 50~60Hz. The Max lamps power is 60W TYPE B Bulb.
2. Avoid to scratch the surface of lighting and the wires when install it.
3. Connecting the neutral wire with the white wire, the live wire with the black wire, the earth wire with the earth symbol (L-L, N-N).
4. Don't install it to the ceiling before it's completely dry, the surrounding around must be ventilated and dry.
5. Keep away from the acid, basicity objects and gases, clean with soft cloth, water washing is not allowed.
6. The lighting must be installed by professional electrician and used indoor only.
7. Please keep attention to cut off the power supply when installing, cleaning, and replacing bulb.