

Features

- Premium construction ensures durability and reliability.
- Lever handle.
- 35° spout.
- Push-button diverter.
- NPT connection.
- KOHLER finishes resist corrosion and tarnishing, exceeding industry durability standards by over two times.
- Rite-Temp® pressure-balancing technology maintains water temperature within +/-3 degrees Fahrenheit.
- High-temperature limit stop allows you to preset a comfortable maximum temperature to eliminate scalding.
- Completes Purist design solution with KOHLER fixtures and accessories.
- Premium material construction for durability and reliability
- "Deck or Bath-Mount installation"
- Rite-Temp® pressure-balancing technology maintains water temperature within +/-3 degrees Fahrenheit
- High-temperature limit stop allows you to preset a comfortable maximum temperature to eliminate scalding
- Completes Purist design solution with KOHLER fixtures and accessories

Required Products/Accessories

K-11748 Series Rite-Temp® Valves

Optional Products/Accessories

88526 Thin Wall Trim Kit

1016154 Rite-Temp® Deep Rough-In



Codes/Standards

ASME A112.18.1/CSA B125.1











DOE - Energy Policy Act 1992

KOHLER® Faucet Lifetime Limited Warranty

See website for detailed warranty information.

Available Colors/Finishes

Color tiles intended for reference only.

Color	Code	Description
	CP	Polished Chrome
	SN	Vibrant® Polished Nickel
	AF	Vibrant® French Gold
	PGD	Vibrant® Moderne Polished Gold
	BGD	Vibrant® Moderne Brushed Gold
	G	Brushed Chrome
	BN	Vibrant® Brushed Nickel
	BV	Vibrant® Brushed Bronze
	2MB	Vibrant Brushed Moderne Brass
	RGD	Vibrant Rose Gold

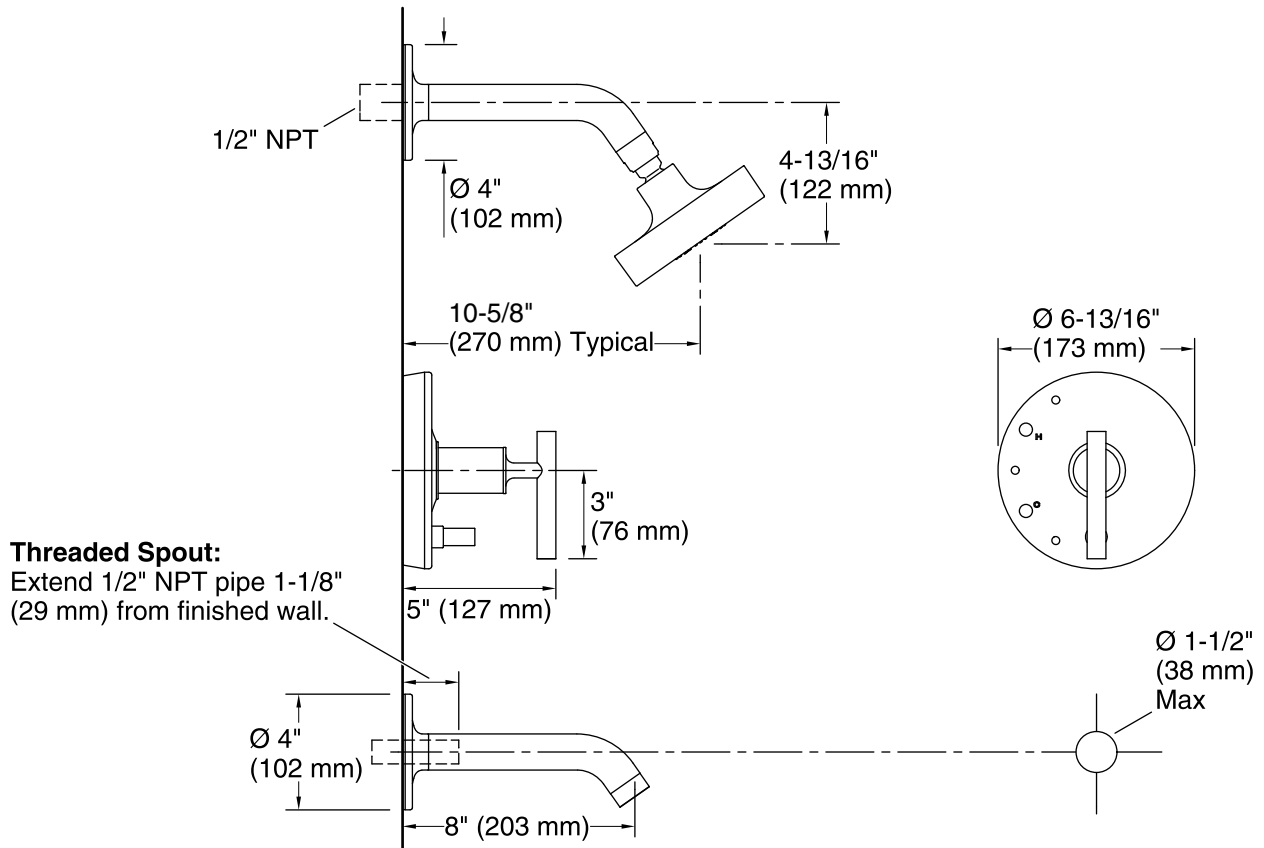

Technical Information

All product dimensions are nominal.

Showerhead/Body Spray:

Rated maximum flow: 2.5 gal/min (9.5 l/min)

Pressure: 80 psi (5.5 bar)

Notes

Install this product according to the installation guide.

Avoid cross-flow conditions. Do not install shut-off device on either valve outlet.

Cap the shower outlet if deck-mount spout, diverter, or handshower is connected to the spout outlet.

Install straight pipe or tube drop of 7" (178 mm) to 18" (457 mm) with single elbow between valve and wall-mount spout.