

### Features

- KOHLER ceramic disc valves exceed industry longevity standards over two times for a lifetime of durable performance.
- Premium material construction for durability and reliability.
- KOHLER finishes resist corrosion and tarnishing, exceeding industry durability standards over two times.
- Easier installation with the integral diverter on the valve.
- Provides a cleaner deck environment and reduces cost.
- Completes Devonshire design solution with KOHLER® fixtures and accessories.

### Required Products/Accessories

K-438-K High-Flow Bath Valve with Diverter

### Optional Products/Accessories

K-10597 Multifunction Handshower

K-10573 Deck-Mount Handshower Holder With Hoses



ADA

### Codes/Standards







ADA

### KOHLER® Faucet Lifetime Limited Warranty

See website for detailed warranty information.

### Available Colors/Finishes

*Color tiles intended for reference only.*

Color	Code	Description
	CP	Polished Chrome
	SN	Vibrant® Polished Nickel
	BN	Vibrant® Brushed Nickel
	BV	Vibrant® Brushed Bronze
	BRZ	Oil-Rubbed Bronze
	2BZ	Oil-Rubbed Bronze

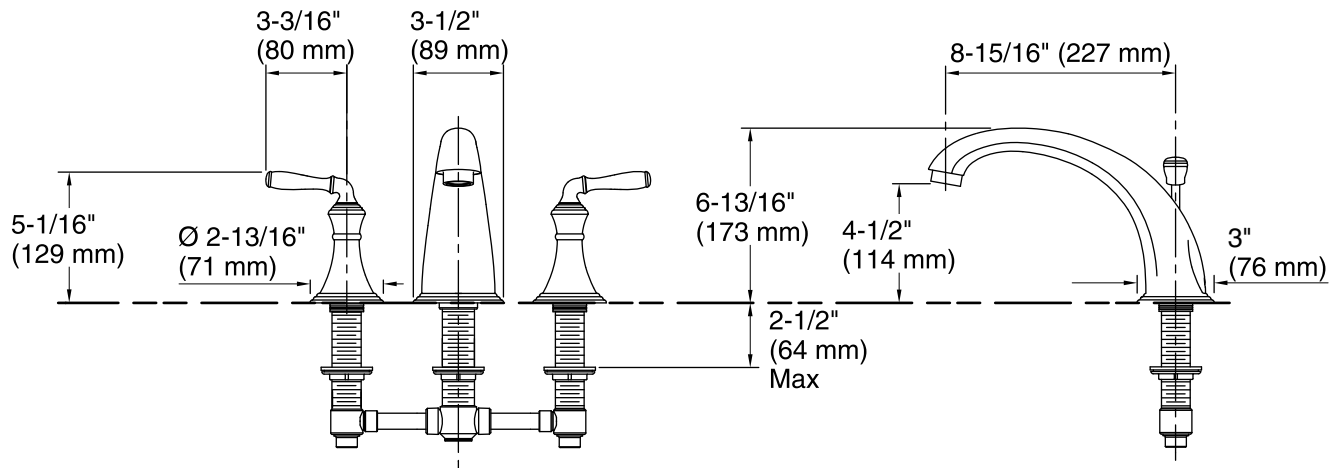

### Technical Information

All product dimensions are nominal.

### Notes

Install this product according to the installation guide.

ADA compliant when installed to the specific requirements of these regulations.