

# CANOPY INSTALLATION INSTRUCTIONS

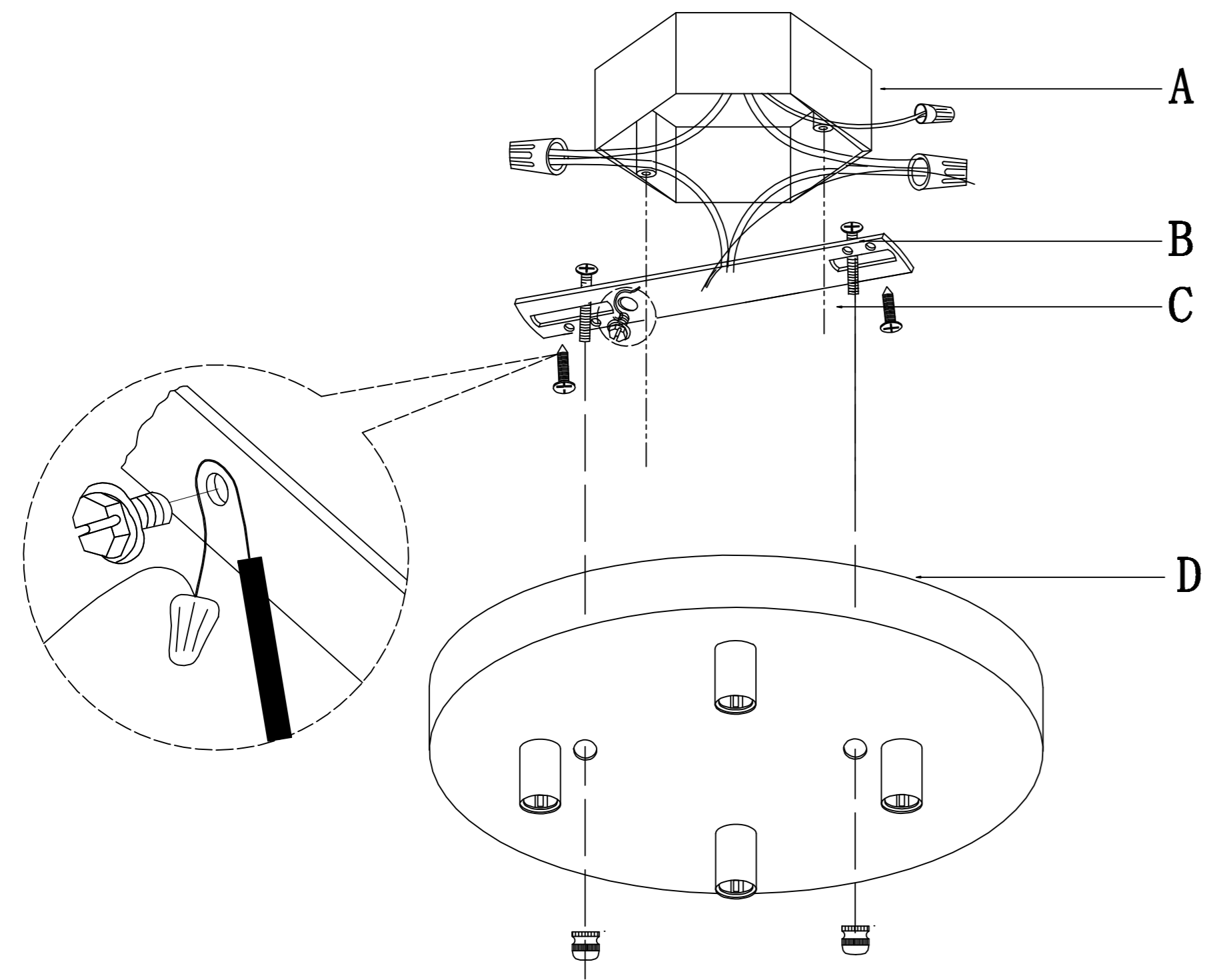

## Attentions for lamp installation:

1. Please read the user manual carefully before the installation.
2. Please hire the professional electrician to install the lamp.
3. The load-bearing of the customer's ceiling must be over 3 times of the light weight.
4. The power must be cut off until the whole lamp is installed well.
5. To avoid getting an electric shock and cause the unnecessary hurt, please cut off the power when cleaning the lamp.

- A. Existing Electrical Box.      B. Crossbar.      C. Crossbar Screws.  
 D. Canopy.

## Light Bulb

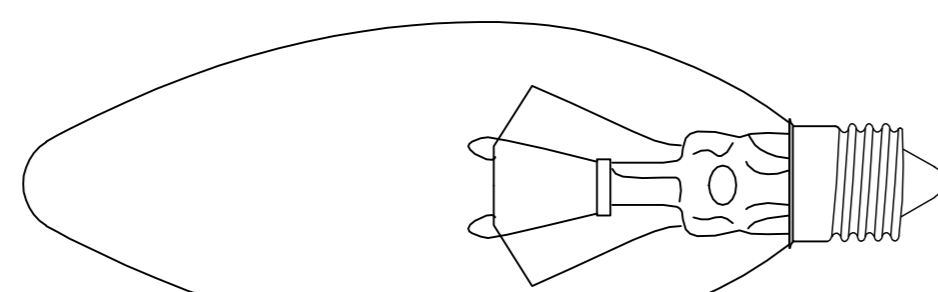

**E12**

# USER MANUAL FOR MODEL# HG8990

Light Bulb:E12      light:E12\*4

( Rated 110-130V/60Hz, bulb 40W-60W maximum. )

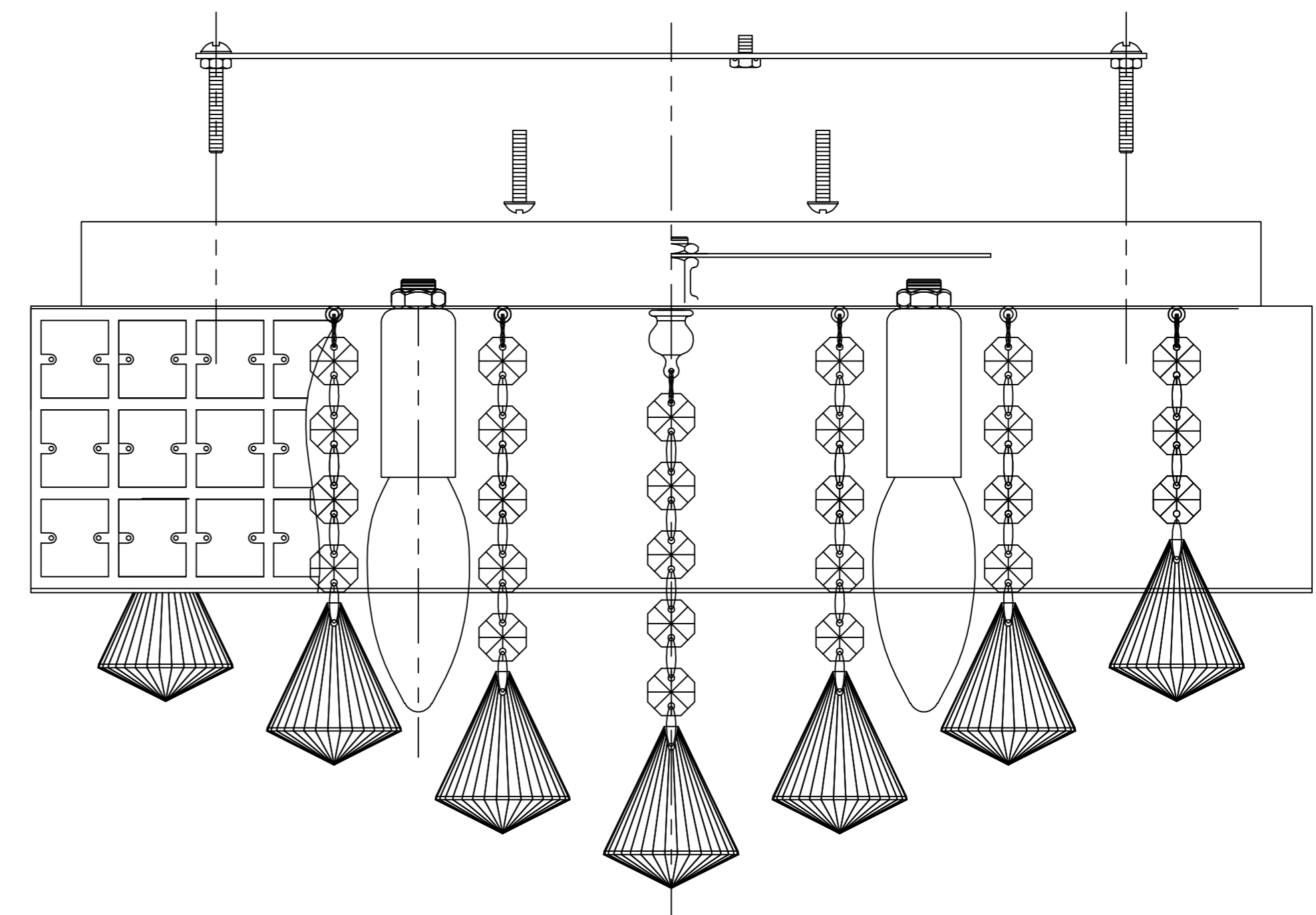

**Please note: The parts in this table are completely unassembled, for illustrative purpose. In the actual product that you receive, some parts are assembled and attached together.**

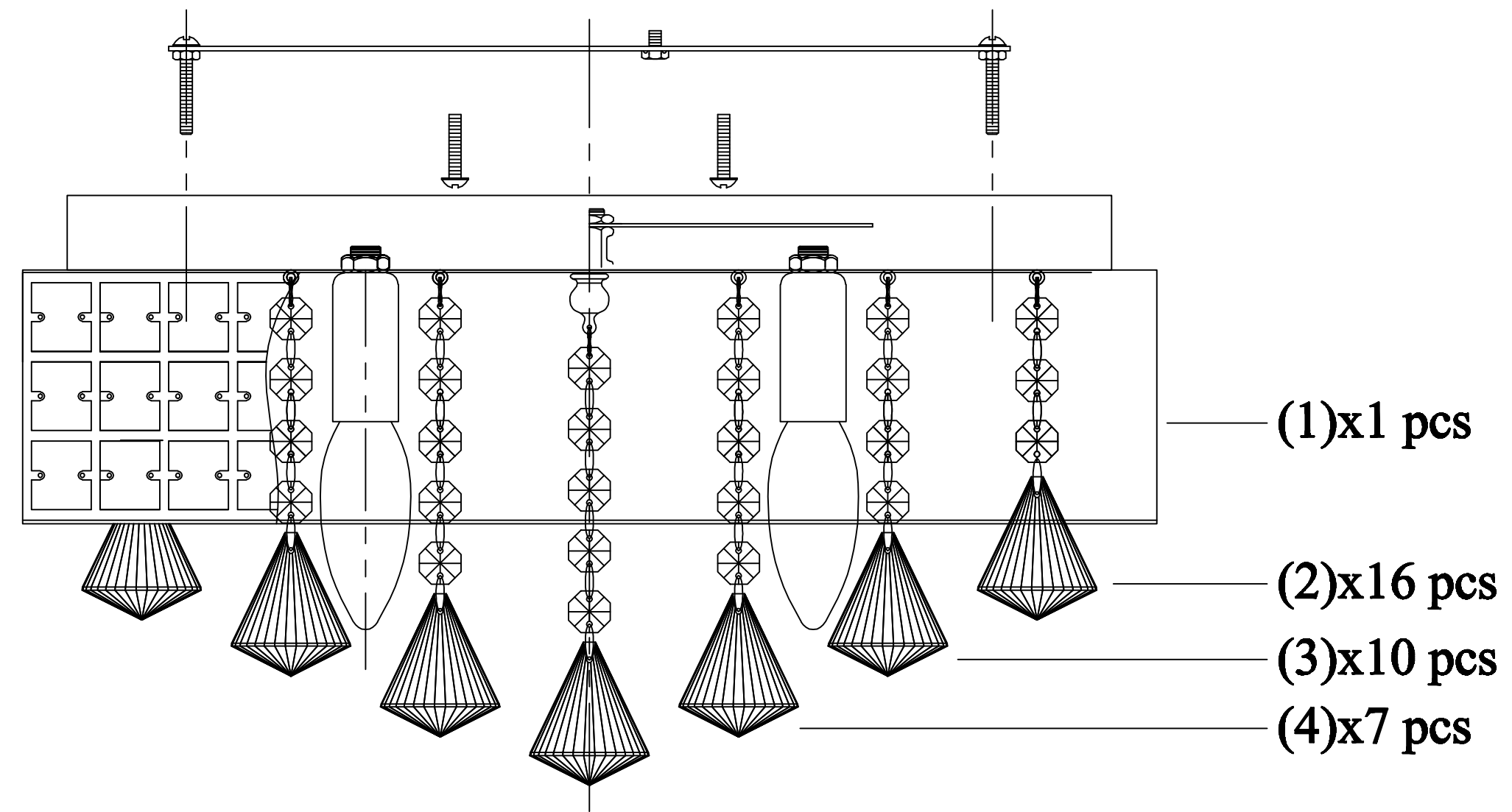

# Products list

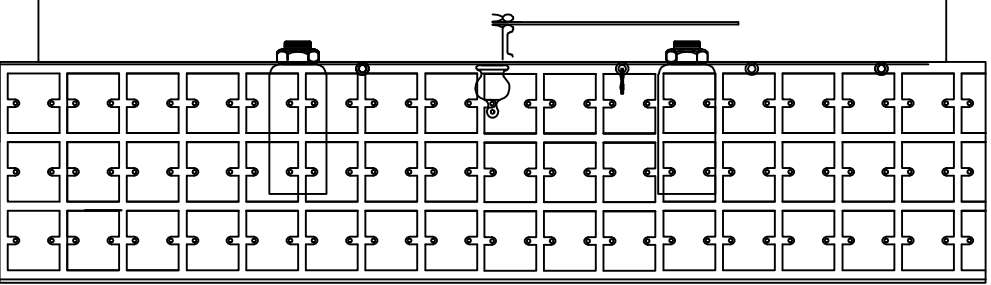
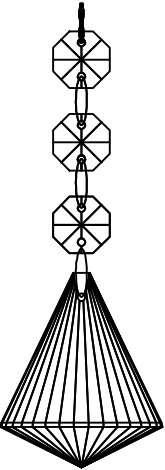
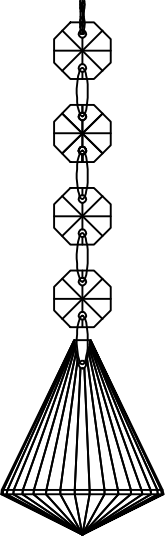
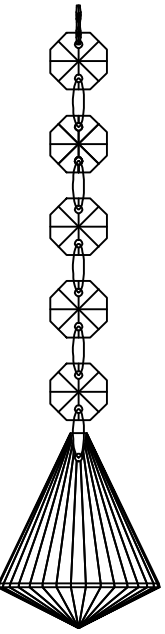
NO.	Picture	Quantity
1		1 PCS
2		16 PCS
3		10 PCS
4		7 PCS

# Assembly and Installation Steps

1: Used two screws lock on the ceiling tightly to fix the light.

2: Mounted in particular.

3: The lamp body with small chains on the chassis.

4: Install the bulb.

5: The steps of hanging crystals.

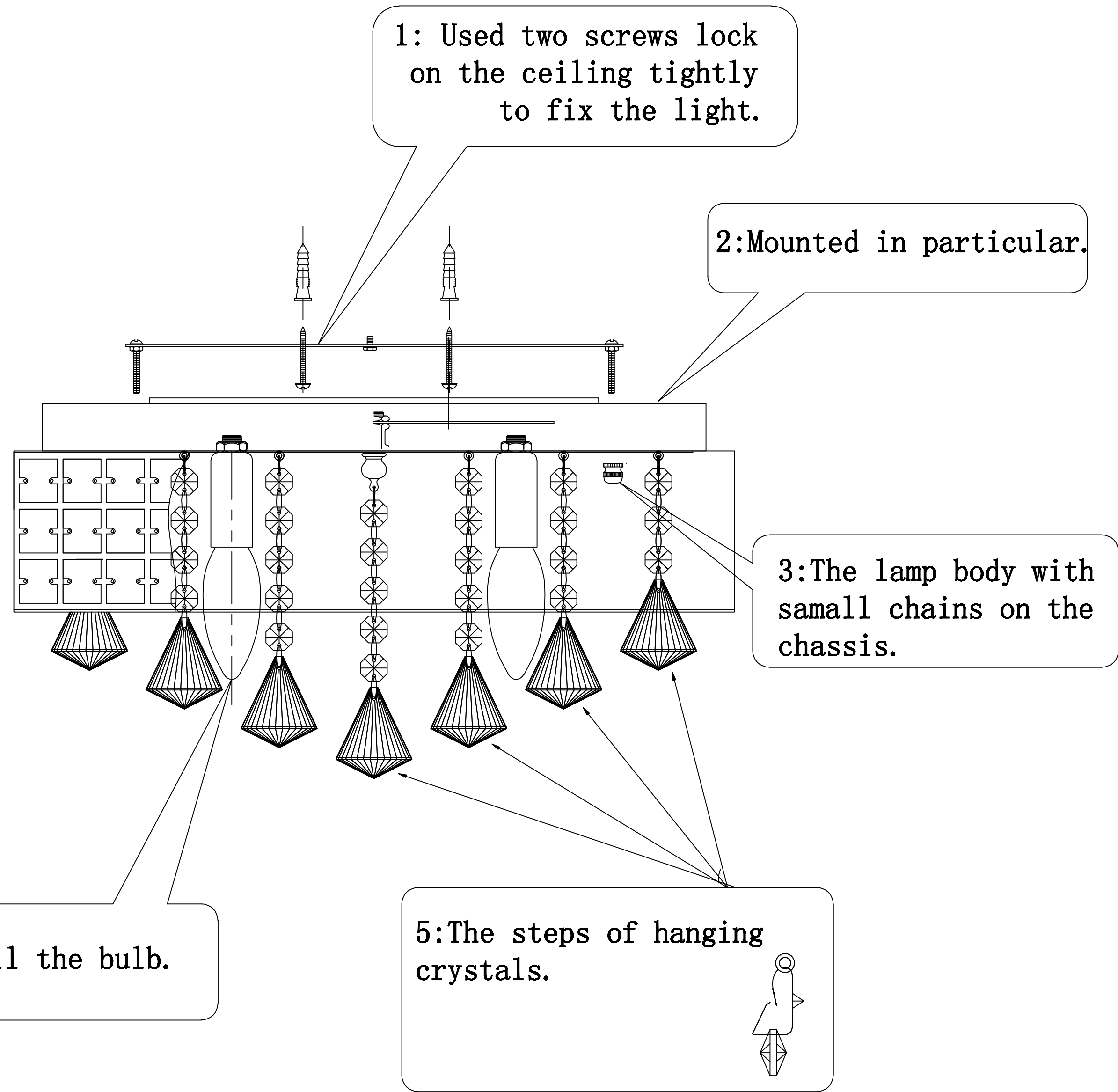

# Product Size

