

4" G9 KISS CANOPY PENDANTS

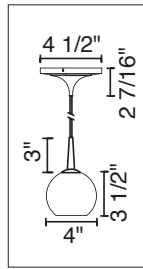

BOBO DOWN
320 915(bz,ch,mc)/MP
320 917(bz,ch,mc)/MP

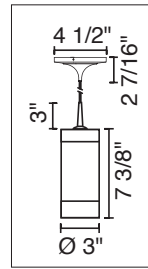

SILVA DOWN
320 711(bz,ch,mc)/MP
320 712(bz,ch,mc)/MP
320 713(bz,ch,mc)/MP
320 714(bz,ch,mc)/MP
320 715(bz,ch,mc)/MP
320 716(bz,ch,mc)/MP

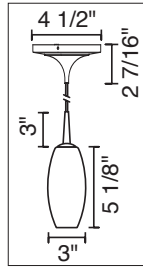

CIRO MINI DOWN
321 830(bz,ch,mc)/MP
321 831(bz,ch,mc)/MP
321 832(bz,ch,mc)/MP
321 833(bz,ch,mc)/MP

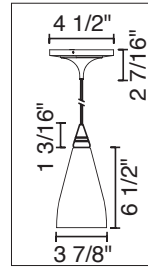

ZARA DOWN
320 151(bz,ch,mc)/MP
320 152(bz,ch,mc)/MP
320 153(bz,ch,mc)/MP
320 154(bz,ch,mc)/MP
320 156(bz,ch,mc)/MP
320 157(bz,ch,mc)/MP

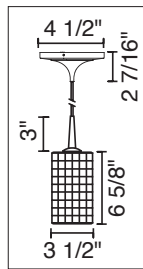

SIERRA DOWN
320 114bz/MP
320 114ch/MP
320 114mc/MP

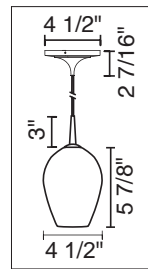

BOLERO DOWN
320 336(bz,ch,mc)/MP
320 337(bz,ch,mc)/MP
320 338(bz,ch,mc)/MP
320 339(bz,ch,mc)/MP

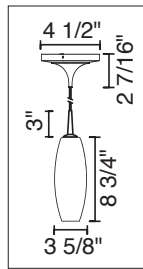

CIRO DOWN
320 116(bz,ch,mc)/MP
320 118(bz,ch,mc)/MP
320 119(bz,ch,mc)/MP
320 121(bz,ch,mc)/MP
320 122(bz,ch,mc)/MP
320 123(bz,ch,mc)/MP
320 124(bz,ch,mc)/MP
320 125(bz,ch,mc)/MP

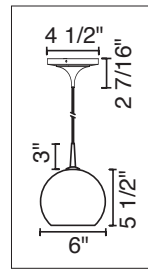

ZON DOWN
321 801bz/MP
321 801ch/MP
321 801mc/MP

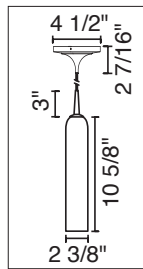

CHIANTI DOWN
321 820(bz,ch,mc)/MP
321 821(bz,ch,mc)/MP
321 822(bz,ch,mc)/MP
321 823(bz,ch,mc)/MP

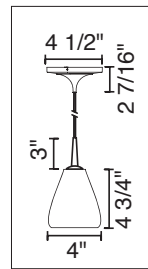

LUCY DOWN
320 126(bz,ch,mc)/MP
320 127(bz,ch,mc)/MP
320 128(bz,ch,mc)/MP

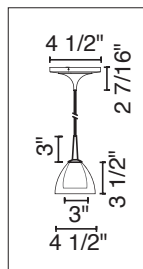

RAINBOW II DOWN
320 725(bz,ch,mc)/MP
320 726(bz,ch,mc)/MP
320 728(bz,ch,mc)/MP
320 729(bz,ch,mc)/MP
320 816(bz,ch,mc)/MP
320 817(bz,ch,mc)/MP
320 916(bz,ch,mc)/MP
320 919(bz,ch,mc)/MP

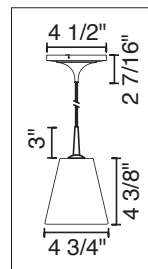

BLING I DOWN
320 168(bz,ch,mc)/MP
320 173(bz,ch,mc)/MP
320 178(bz,ch,mc)/MP
321 840(bz,ch,mc)/MP
321 841(bz,ch,mc)/MP
321 842(bz,ch,mc)/MP

4" G9 KISS CANOPY PENDANTS

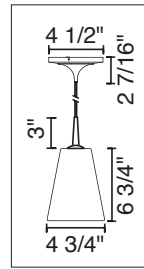

BLING II DOWN
320 169(bz,ch,mc)/MP
320 174(bz,ch,mc)/MP
320 179(bz,ch,mc)/MP
321 843(bz,ch,mc)/MP
321 844(bz,ch,mc)/MP
321 845(bz,ch,mc)/MP

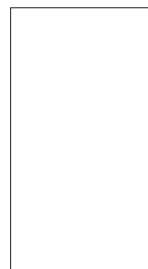
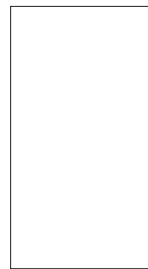
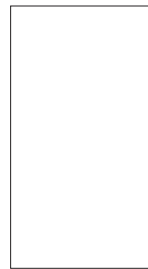
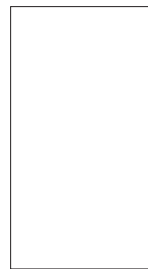
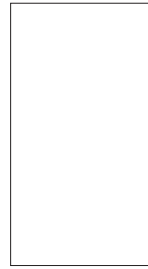
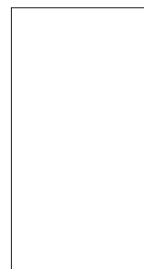
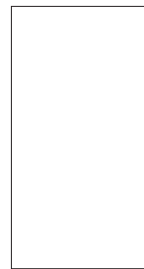
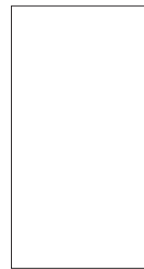
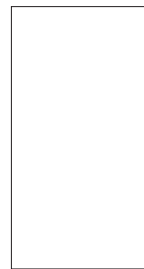
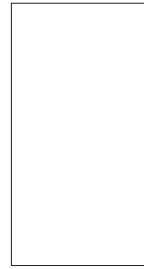

4" G9 KISS CANOPY PENDANTS

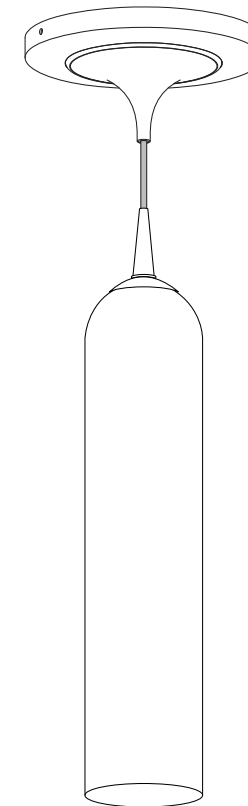

TECHNICAL SPECIFICATIONS

Description: Kiss pendant fixture with canopy
Design: Bruck-Team
Lamp: G9

CONTENTS OF DELIVERY

canopy and fixture complete without lamp



IMPORTANT SAFETY INSTRUCTIONS



1. Save these instructions and refer to them when additions to or changes to the fixture are made.
2. THIS PRODUCT MUST BE INSTALLED BY A PERSON FAMILIAR WITH THE CONSTRUCTION AND OPERATION OF THE PRODUCT AND THE HAZARDS INVOLVED, IN ACCORDANCE WITH THE APPLICABLE NEC CODE.
3. SUITABLE FOR DRY LOCATION ONLY.
4. CAUTION - Do not install any fixture assembly closer than 6 inches from any curtain, or similar combustible material.
5. Turn off power prior to any work on the systems.
6. Please check that the total lamp wattage does not exceed wattage specified by fixture.
7. Warranty is void in case of unauthorized modifications and/ or improper use.

READ ALL OF THESE INSTRUCTIONS BEFORE INSTALLATION

INSTALLATION INSTRUCTIONS

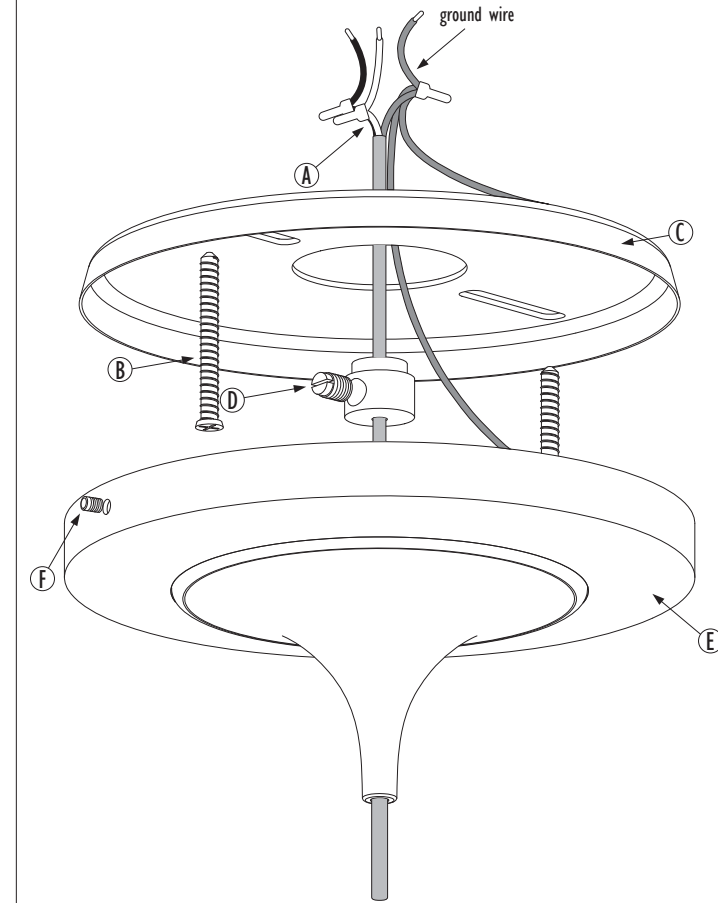

INSTRUCTIONS FOR USE

- Connect the wires (A) to the power cables in the wall. Insert the screw (B) through the mounting plate (C). Securely attach and tighten mounting plate to ceiling.
- Green wire should be grounded in accordance with local electrical codes.
- Adjust the cable length by loosening the center cable lock (d) and coiling excess cable inside the canopy.
- Place the canopy cover (E) over the mounting plate (C) and secure it with the allen screws (F) located on the side of the base.