



Installation Instruction of
AM151ETL-R
TS-series Control panel

Safety Information

1. Please read carefully and follow all instructions when operating.
2. Qualified earth leakage circuit-breaker must be installed and tested with trial jump to certify the device is qualified and safety before using the product.
3. To avoid electrical shock, the replacing of the wire must be done by the electrical engineer or the retailer. Customer could not replace by yourself.
4. Ground wire of massage water pump and air pump must be connected to ground well, the minimum size copper wire of ground wire must not be less than 1.5mm².
5. It is forbid to remodel, add or take part products.
6. Please don't use this product after alcohol or drugs.
7. The children shall be closely supervised by parents to use product.
8. All the electrical spare parts except the remote control must be put suitable and stable to avoid slip into the tub.
9. Warning: the mixed water temperature shall never exceed 60 degree centigrade.
10. Don't use sulphuric acid, hydrochloric acid, lye and other mixed strong corrosive chemical liquid to clean product.
11. The water pump would be very hot when running. Please don't touch the surface of the machine to avoid scald.
12. The water level must be higher than the jet before turning on the product.
13. Please don't drop anything in or insert water pump and the opening hole of machine. The socket position should be suitable.
14. Warning - To prevent risk of electric shock, please connect the GFCI / RCD (earth leakage protection device) socket.
15. Warning - To prevent electric shock, please do not connect any extension cord to the power supply.

16 Caution - please use the product under the following condition: water pressure is 0.15 ~ 0.40MPa, the ground must have the ability to support the estimated load, water can not exceed the overflow level, the washroom need to reserve enough space for proper to handle the overflow of water.

17. WARNING - for bathtub to be used normally please do not grasp the hand wheel drainer, nozzles, piping, handrails, etc., to cause any leakage and other problem when unpacking the product.

Maintenance instruction

1. Clean the acrylic surface:

Clean acrylic surface with cotton flannel or sponge and water in daily life. If there is scratch on the surface, please use No. 1500 water abrasive cloth polishing slightly to clear away scratches, and then polish with toothpaste, cotton flannel. Please don't use strong caustic chemical liquid, such as sulphuric acid, hydrochloric acid, lye during maintenance.

2. Plated item maintenance:

Clean the surface of plated item with cotton flannel, please don't use coarse cloth.

3. Suction net cleaning:

Turn the screw out and take the suction net out to clean dirt, to keep the water going through smoothly. Don't use strong causticity chemical liquid to clean the product, such as sulphuric, hydrochloric acid, lye and so on.

CONTENTS

01	Component Struction
02	Water and wire line instruction diagram
03	Connecting diagram of faucet pipe
04	Installation steps
05	Faucet' s usage instruction
07-11	TS Control Panel
12	Troubleshooting
13-14	Maintenance Card

AM151ETL-R Component Struction

No.	Name	No.	Name
1	Three-piece faucet	19	Bottom light
2	PC board	20	Drain
3	Pillow	21	1 Inch three way
4	Bathtub	22	One way stuff
5	Ozone generator	23	Fitting nut
6	Skirt panel light	24	4CM conversion
7	Light installation pane	25	Suction
8	Lengthened plastic	26	Side jet
9	Water pump	27	½ Inch three way
10	PC board power box	28	Movable straight pipe
11	Bathtub leg	29	Drain valve
12	Stainless steel bracket	30	Hand shower holder
13	Junction box	31	Hand shower
14	Speaker	32	
15	Heater	33	
16	Back jet	34	
17	Drain elbow	35	
18	Deodorized drain	36	

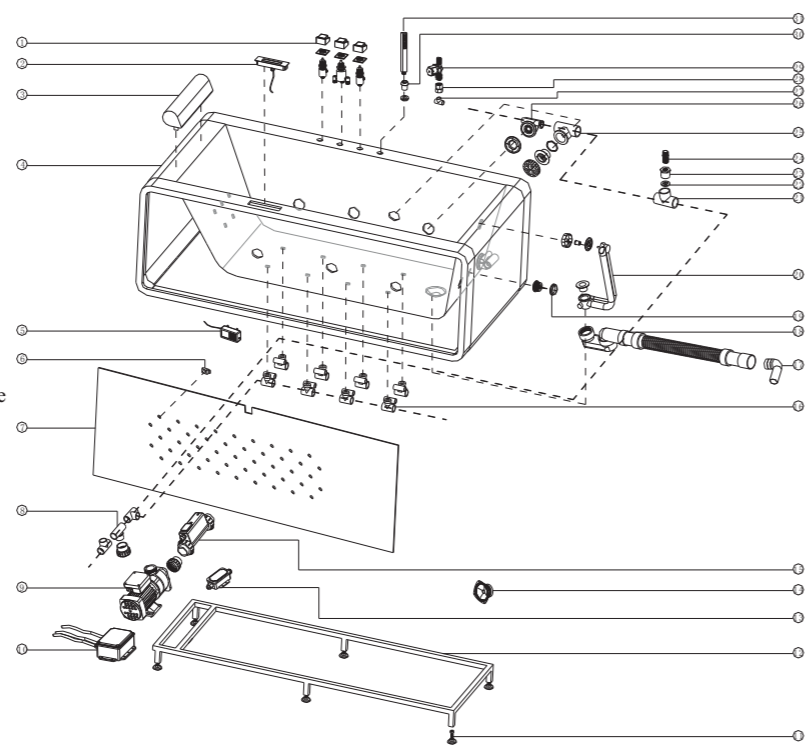

AM151 Water and wire line instruction diagram

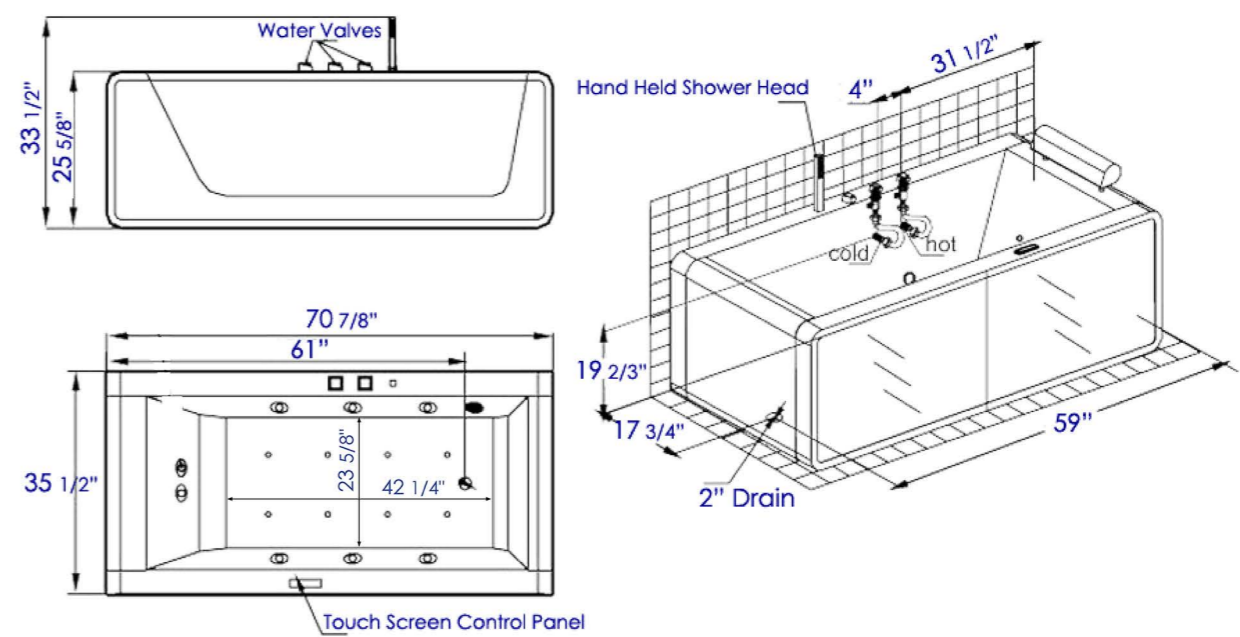

Water pipe of faucet connection diagram

Standard configuration:

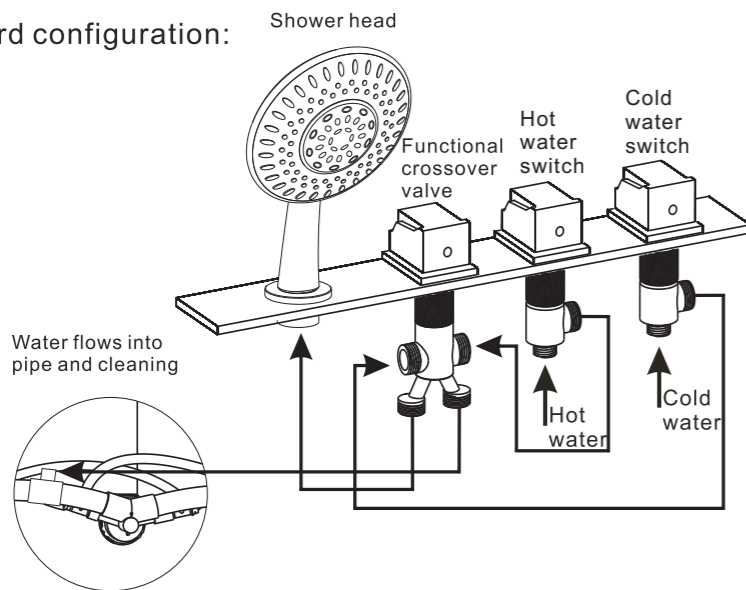

AM146/151/154/156/196

Installation Steps

The product adopts standard accessories, please follow product specifications to install product:

1. Confirm product installation place→2. adjust product to level→3. connect water inlet and drainage pipes→4. connect power→5. check and clean→6. reset→7. test with water.

1. Confirm product installation place

Please refer product specifications to arrange sewage pipes, power socket and water inlet pipe, then check if there is enough space to connect every part.

2. Adjust product to level

Adjust movable ground leg of product till level.

3. Connect water inlet and drainage pipes

Drainage pipe is in the bottom of tub, the diameter of water drainage outlet is 38mm, and pipe could be bended and stretched; inserting drainage pipe elbow of tub into customer's drainage system pipe with adhesive tape or glass cement during connection. In case of influencing draining water, pipe could not be folded or squashed.

4. The Power Connection

The product is adequate for all purchasing requirement power, please follow technical parameter to install power socket and prevent from water, put plug into power socket. (Note: yellow & green wire of water pump are ground wires, diameter of ground wire is 8mm)

5. Check and clean

After above steps, please check that if the each joint is sealed well, and then clean up sundries of tub. Open drainer to clean tub with water. To prevent sundries or floating objects stuck in water pump from pipes and nozzle jamming; please clean sundries out from tub.

6. Reset

Move product to installation place.

7. Test with water

Please confirm the tub is cleaned up, and then close drainer to store water. Check if there is leakage during water test. Till water is higher than water level probe, follow functions instruction of control panel to operate product.

Faucet switch diagram

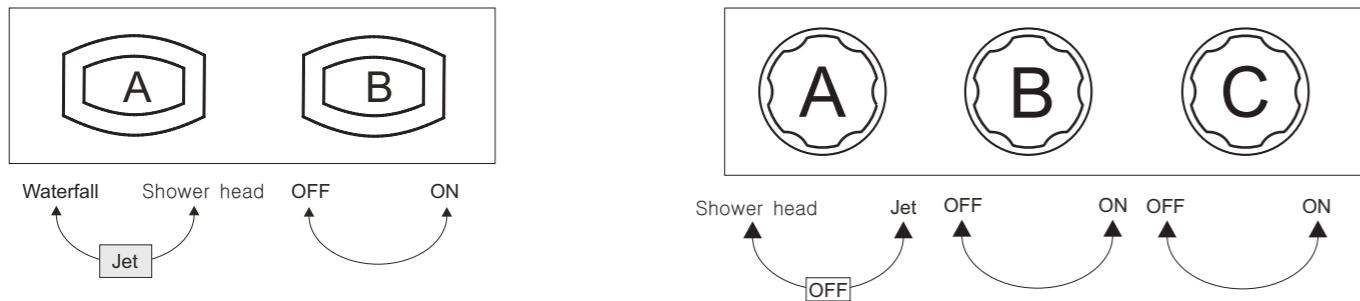

Instruction

Two sets of the faucet:

- A. The faucet is the function conversion. Turn 90° left is the pipe cleaning function while 90° right is the shower head.
- B. The cold-hot water inlet valve is both for hot and cold water. The one with red label or with H mark is for hot water, while the one with blue label or with C mark is for cold water. You could adjust the label on the faucet to get your wanted temperature.

Three sets of the faucet:

- A. Function conversion value. Turn 90° left is the pipe cleaning function while 90° right is the shower head.
- B. The water-in pipe where with blue label is cold water, and the hand-hole faucet with label C is also cold water. Turning left could alternate the volume of the cold water. The maximum is 90° to the left.
- C. The water-in pipe where with red label is hot water, and the hand-hole faucet with label H is also hot water. Turning left could alternate volume of the hot water. The maximum is 90° to the left.

The product designs for water going in from nozzle, also could be used to adjust shower head water in or water in from water outlet faucet. Water in from shower head is usually for body, head cleaning or etc. places.

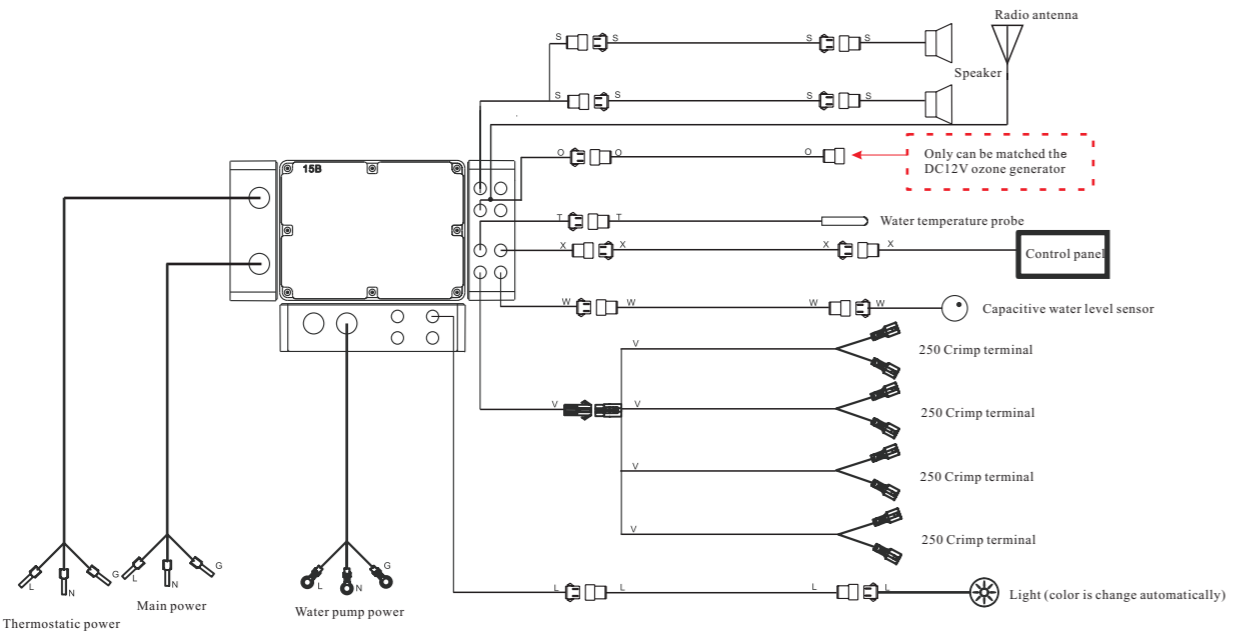

Electric parameter

Spare part	Massage pump	Ozone generator	Bottom light	Thermostatic	Electromagnetism valve	Control panel	Speaker	Note
Rate voltage	AC220-240V/50HZ	AC12V	DC12V	AC220V/50HZ	DC12V	AC220V/50HZ		
Rate voltage	AC110-120V/60HZ	AC12V	DC12V	AC120V/60HZ	DC12V	AC120V/60HZ		
Rate power	1125W	5W	3W	1500W	5W		15W	

Control Panel Functions

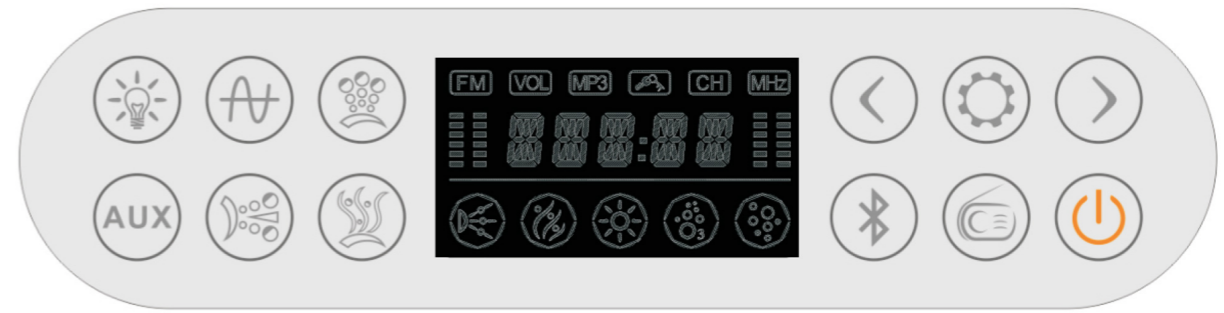

- Light
- Jet Strength
- Jets
- N/A
- Jet Mode
- Heater
- Volume Down Channel Down Previous
- Settings
- Radio
- Bluetooth
- Volume Up Channel Up Next
- On/Off

The characteristics of the control system electrical box

- 1) Rated voltage: AC220V-240V/AC110V-120V
- 2) Rated frequency: 50HZ/60HZ
- 3) Standby Power: <10W (All load is closed)
- 4) Ambient temperature: +5℃~+40℃









Devices being controlled by control system

- 1) Surfing water pump: 2HP
- 2) Heater: 1500W
- 3) Bottom light: DC12V/1W
- 4) Electromagnetism valve: 4*DC12V/5W
- 5) Ozone generator: DC12V/6W
- 6) Speaker: 8Ω/15W (Maximum)







Control panel operation instruction











1. Press any key a buzzer would let out.
2. “” On/Off
 - 2.1 The control system starts operation when touch this key, the bottom lights would turn on at the same time.; press this key again to turn off the control system.
 - 2.2 The control system would turn off automatically when it turn on 60 minutes later, and all the load would turn off.
3. Child lock

The control system would lock all keys automatically when you do not use the control panel in 5 minutes. The LCD shows “LOCK” icon. To unlock the control panel by pressing any key, the “LOCK” icon disappear.
4. “” light

Each time to touch “” lights would change to another color, the LCD shows a light icon when the control system turns on; the lights colors would change circularly when touch “” the seventh times; the lights would turn off when touch “” for the eighth times.
5. “” Jet Mode
 - 5.1 There is water level sensor in the control system to prevent water pump from running idle to damage water pump under less water or without water.
 - 5.2 The jet function would turn on when touch “”, the LCD shows “” icon. The water pump would not work when the water level sensor test the water level is below the set value, the “” icon twinkle. The water pump would start to work when the water level sensor test the water level reaches to the set value, the “” shows dynamic.
 - 5.3 Touch “” turn off the water pump when the jet function is turn on, and the jet mode icon would disappear. Also the heater would turn off (if the heater is turn on).







6. “” Jet

Touch “” to turn on the jet, one admission valve works, touch “” for the first time, two admission valves work; touch “” for the second time, three admission valves work; touch “” for the third time, four admission valves work; touch “” for the fourth time, four admission valves turn off; So the cycle to repeat.
7. “” Jet Strength

Touch “” to turn on the jet strength, one admission valve works, touch “” for the first time, air inlet circular with 3 seconds interval. The order is: one admission valve, two admission valves, three admission valves, four admission valves, three admission valves, two admission valves, one admission valve. Touch “” for the second time, four admission valves work for 2 seconds, and turn off for 1 second. So the cycle to repeat. Touch “” for the third time, four admission valves turn off. So the cycle to repeat.
8. “” Radio
 - 8.1 Touch the “” to turn on the radio when the control system is turn on, the LCD shows the current frequency and “” “” icon; touch the “” again to turn on the radio, the current frequency and “” “” icon shows on LCD disappear.
 - 8.2 FM broadcast receiving frequency range is 87.5MHz---108.0MHz.
 - 8.3 Frequency increase

Touch “” to increase a step length (1 step length = 50KHz) tuned frequency when the radio turns on. Touch this key for more than 2 seconds, the system would search FM program upwards, digital lock would lock the program automatically, LCD shows the corresponsive frequency; when it reaches upper limit 108.0MHz and touch this key, the frequency will turn to 87.5MHz.
 - 8.4 Frequency decrease









Touch “” to decrease a step length (1 step length = 50KHz) tuned frequency when the radio turns on. Touch this key for more than 2 seconds, the system would search FM program downwards, digital lock would lock the program automatically, LCD shows the corresponsive frequency; when it reaches lower limit 87.5MHz and touch this key, the frequency will turn to 108.0MHz.
 - 8.5 Volume adjustment

Touch “” when radio turns on, LCD flicker “VOL” and number means the volume can be adjusted. Touch “” to increase the volume, touch “” to decrease volume. The volume range is 0-20.
 - 8.6 Channel saving/channel picking out
 - 8.6.1 Channel saving: select the channel need to save when the radio turns on, touch “” the LCD flicker “CH” icon, touch “” or “” to choose the saving position, the channel can be saved in this position when touch “” for 2 seconds again.









TS Control panel instruction

8.6.2 Channel picking out: touch “” when the radio turns on, the LCD shows the corresponsive channel and “CH” icon, touch “” or “” to pick out the corresponsive channel.

9. Bluetooth

- 9.1 When the control system turns on and the radio turns off, touch “” for 2 seconds to disconnect the corresponsive device and search the new device again.
- 9.2 When the control system turns on and touch “” to turn on the bluetooth music playing function, LCD shows “BT--C”; touch “” again to turn off the bluetooth music playing function, “BT--C” disappear.
- 9.3 If the bluetooth pairing failed, LCD flicker shows “BT--C”; if succeed, LCD constant shows “BT--C”.
- 9.4 When the bluetooth music playing function turns on, touch “” or “” to choose previous or next music.
- 9.5 When the bluetooth music playing function turns on, touch “” to play or pause music.
- 9.6 Touch “” bluetooth music playing function turns on, LCD flicker “VOL” and number means the volume can be adjusted. Touch “” or “” to adjust volume.

10. Heater

- 10.1 The heater can not be turned on until the surfing water pump turns on.
- 10.2 Touch “” to turn on the heater function, LCD constant shows “” icon. The heater would start or stop to work according to the temperature inside the bathtub and the setting temperature (acquiescent temperature is 37°C).
- 10.3 Touch “” again to turn off the heater.
- 10.4 Temperature setting
- 10.4.1 Turn on the heater and touch “”, LCD flicker shows temperature and “°C”, touch “” or “” to set the temperature. The LCD shows the correponsive temperature. Each time to touch “” the temperature would raise 1°C; each time to touch “” the temperature would drop 1°C; the temperature would disappear when you do not touch these two keys 5 seconds later.
- 10.4.2 Temperature range: 30°C--45°C.

11. Ozone

Touch “” to turn on the ozone. It would turn off automatically when it works for 10 minutes; touch “” to turn off the ozone manually.

Troubleshooting Instructions

Problem	Cause	Solution	Problem	Cause	Solution
Bathtub shaking anomaly and loud noise	1.The botton frame of bathtub is imbalance, nut is not screwed down. 2.Fixed screws of motor and shockproof glue are not enough or fall off. 3.Motor idling. 4.Motor failures.	1.Put the bathtub on a level surface, adjust bottom frame till level, and screw nut tightly. 2.There should be 4 screws and 4 shockproof rubber gaskets to fix motor, tighten the screws. 3.Add water to required level—water level is higher than probe screw. 4.Contact distributor or EAGO company.	Chromatic lamp off.	1.Plug off. 2.Control circuit panel failure.	1.Reconnect plug. 2.Contact distributor or EAGO after sale service department.
			Insufficient water flow.	1.Water pressure of water inlet pipe is too low. 2.Water inlet pipe is stuck.	1.Check water pressure of water inlet pipe. 2.Clean filter.
			Shunt valve failure.	1. Rubber gasket of valve broken.	1.Replace a new one.
Motor runs normally, but no water spray out or abnormal water pressure of nozzle (Water pressure is not enough.)	1.Part of backwater net is blocked. 2.Water level is too low. 3.Hydraulic governor is off. 4.There is air during water into water pump. 5.Others.	1.Take apart backwater net to clean with screwdriver and clear away sundries to keep water pass through fluently. 2.Add water to normal requirement—higher than probe screw. 3.Turn on Hydraulic governor. 4.a) Turn on cleaning function valve to exhaust air. b) To prevent air in pipes, tighten water inlet pipe components of water pump. 5. Water pipe and air pipe are conn—ected contrarily; please contact professional personnel to mend.	No air out from massage nozzle.	1.Sundries stuck in air pipe. 2.Air pump is off. 3.Air pump does not work.	1.Take off nozzle and dredge little air pipe with iron wire. 2.Turn on air pump. 3.Follow air pump function failure steps to check.
			Water exhaust device doesn't bounce or leak water.	1.Screws become loosened or adjust too low. 2.Zipper of water exhaust device is broken. 3.Rubber gasket is not flat	1.Take off water exhaust device, tighten screw or readjust screw to suitable place. 2.Replace whole set if it is true. 3.Level up water exhaust device and reinstall it.
Some water leave in pipes.				Because specific structure of some individual massage bathtub, it is not equipped with water exhaust function.	
Massage motor or air pump does not work.	1.Abnormal voltage or power connection failure. 2.Fuse burns down or anticreeping switch tripping operation. 3.Nothing displays on circuit panel. 4.No water level probe signal. 5.Baroswitch broken.	1.Switching power switch. 2.After professional electrician check there is no abnormal situation, replacing fuse or switching anticreeping switch. 3.Contact distributor or EAGO after sale service department. 4.Add water to normal level—add water higher than probe screw. 5.Professional electrician replaces the same model baroswitch.			

