

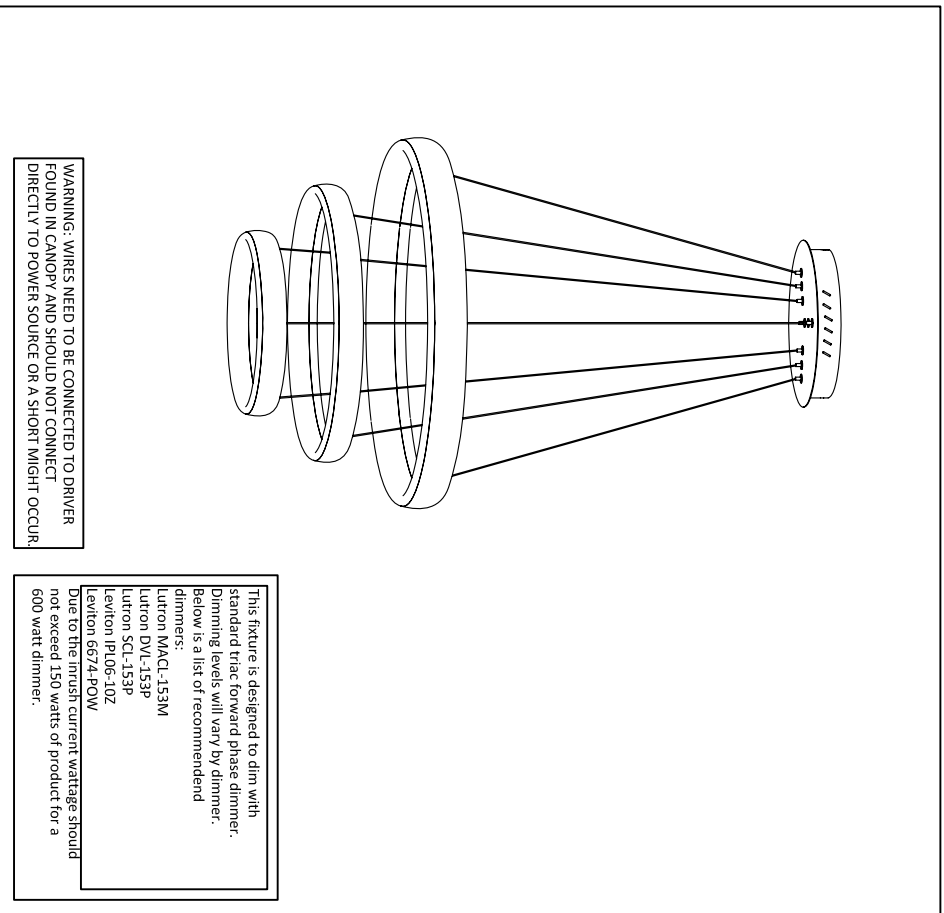

Contemporary™ Lighting

PRODUCT NAME: INNER TUBE
ITEM NUMBER: E10038-SN

Please consult your electrician for hanging fixture and wiring.



MADE IN CHINA
Page 1 of (2)

IMPORTANT: Turn off the power at the main fuse or circuit breaker box before starting installation

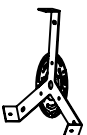

Bracket (A)

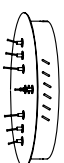

Canopy (B)

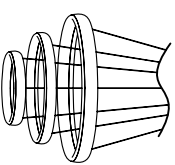

Body (C)

Locate all hardware & components before discarding packaging

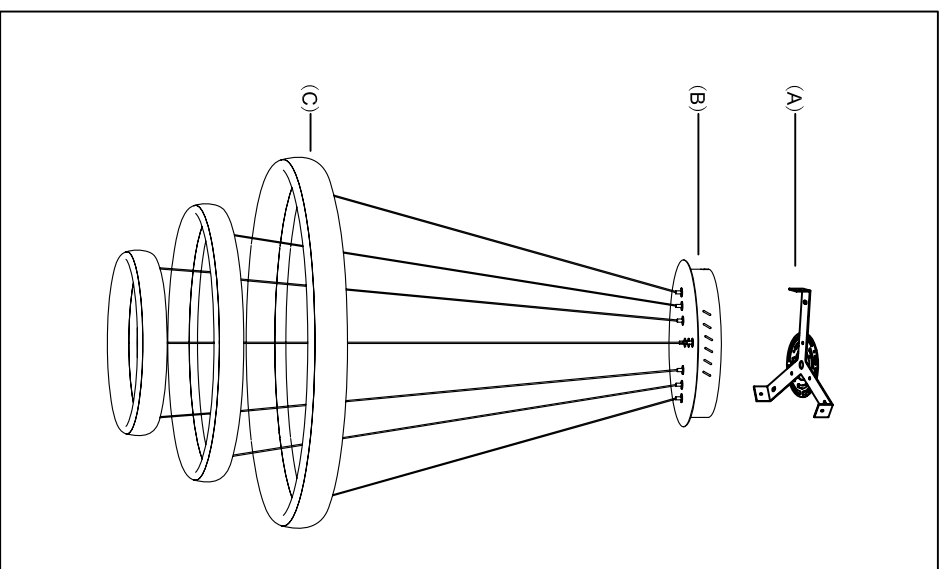

Step 1: Remove Bracket (A) from fixture and install to electrical box.

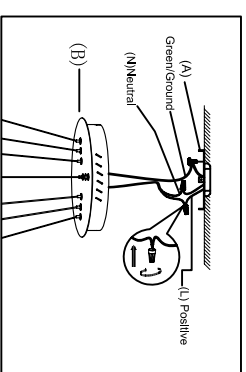

Step 2: Wire fixture to wires in outlet box. Install Green wire to Ground Screw.

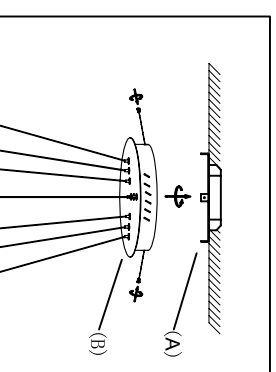

Step 3: Adjust wire length to desired hanging height. Install Canopy (B) to Bracket (A) and tighten screws at the end of canopy to secure.

Cleaning & Care:
Clean with soft cloth and a mild detergent.
Do not use abrasive cleaner.

Page 2 of (2)