

CANOPY INSTALLATION INSTRUCTIONS

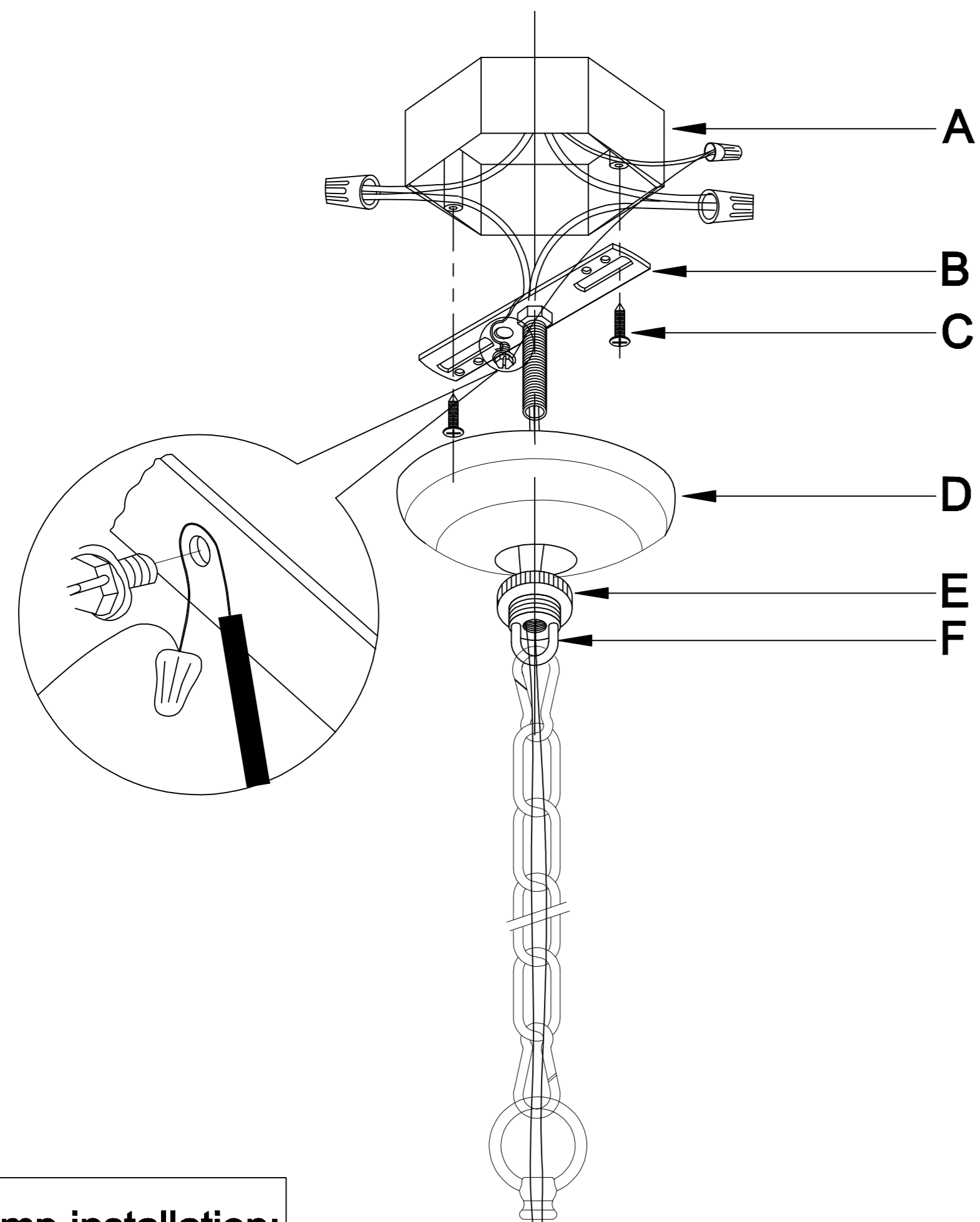

Attentions for lamp installation:

1. Please read the user manual carefully before the installation.
2. Please hire the professional electrician to install the lamp.
3. The load-bearing of the customer's ceiling must be over 3 times of the light weight.
4. The power must be cut off until the whole lamp is installed well.
5. To avoid getting an electric shock and cause the unnecessary hurt, please cut off the power when cleaning the lamp.

- | | | |
|----------------------------|-------------------------|--------------------|
| A. Existing Electrical Box | B. Crossbar | C. Crossbar Screws |
| D. Canopy | E. Canopy Loop Nut lock | F. Canopy Loop |

Light Bulb

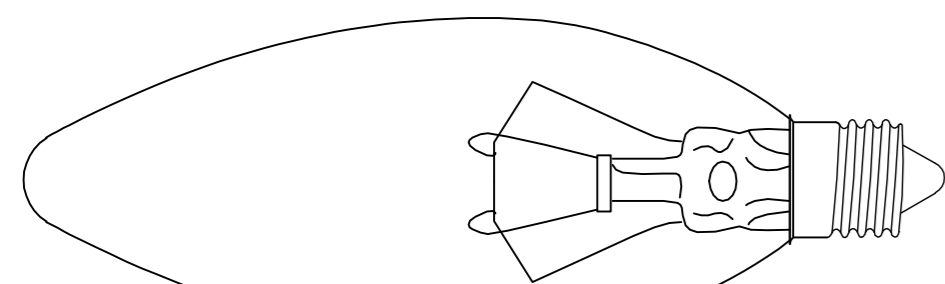

E12

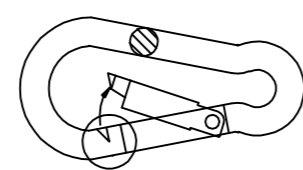

Buckle is used to connect the chain and loop or adjust the length of chain.

USER MANUAL FOR MODEL# HG8854

Light Bulb:E12 light:E12*3

(Rated 110-130V/60Hz, bulb 40W-60W maximum.)

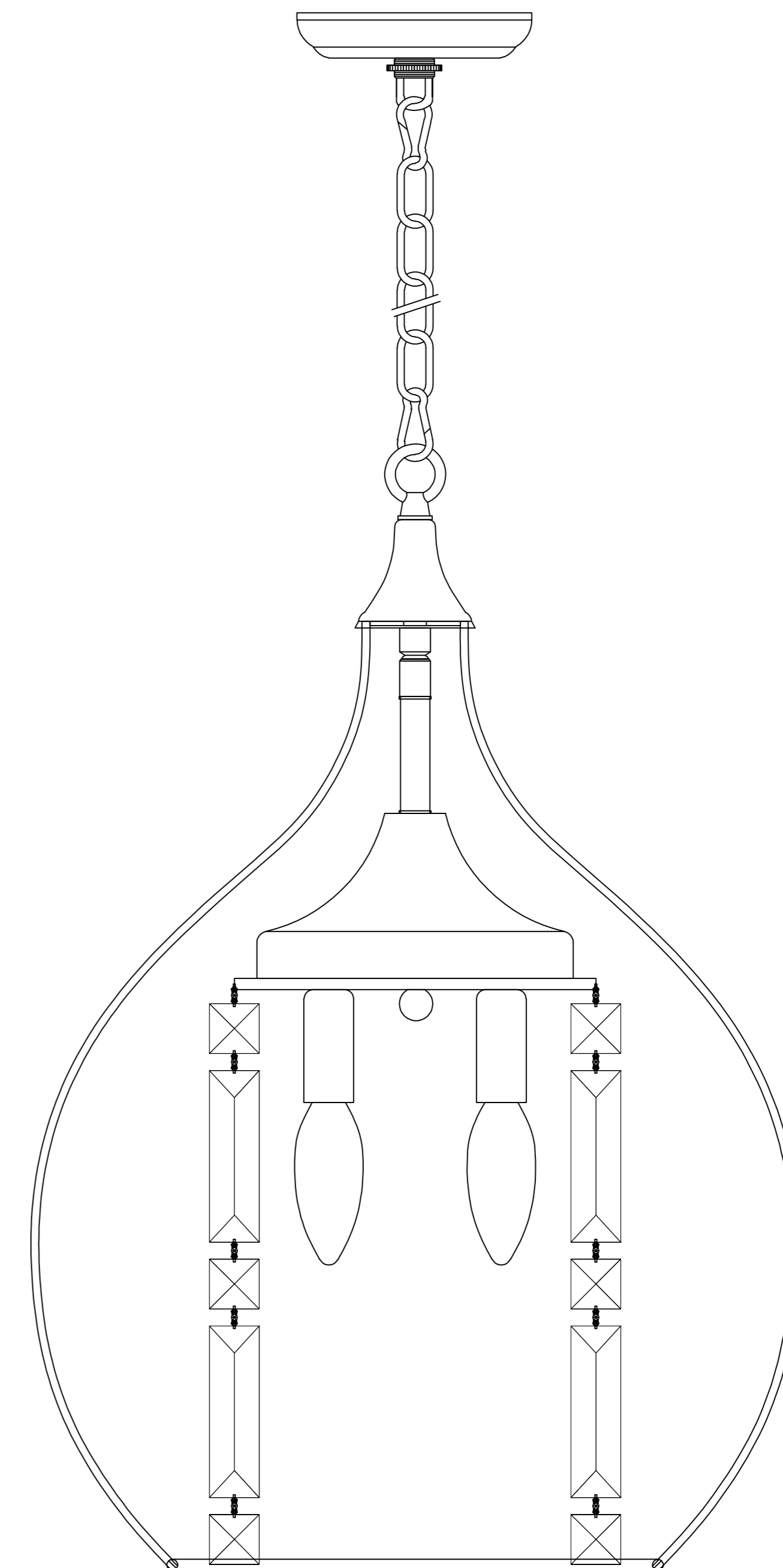

Please note: The parts in this table are completely unassembled, for illustrative purpose. In the actual product that you receive, some parts are assembled and attached together.

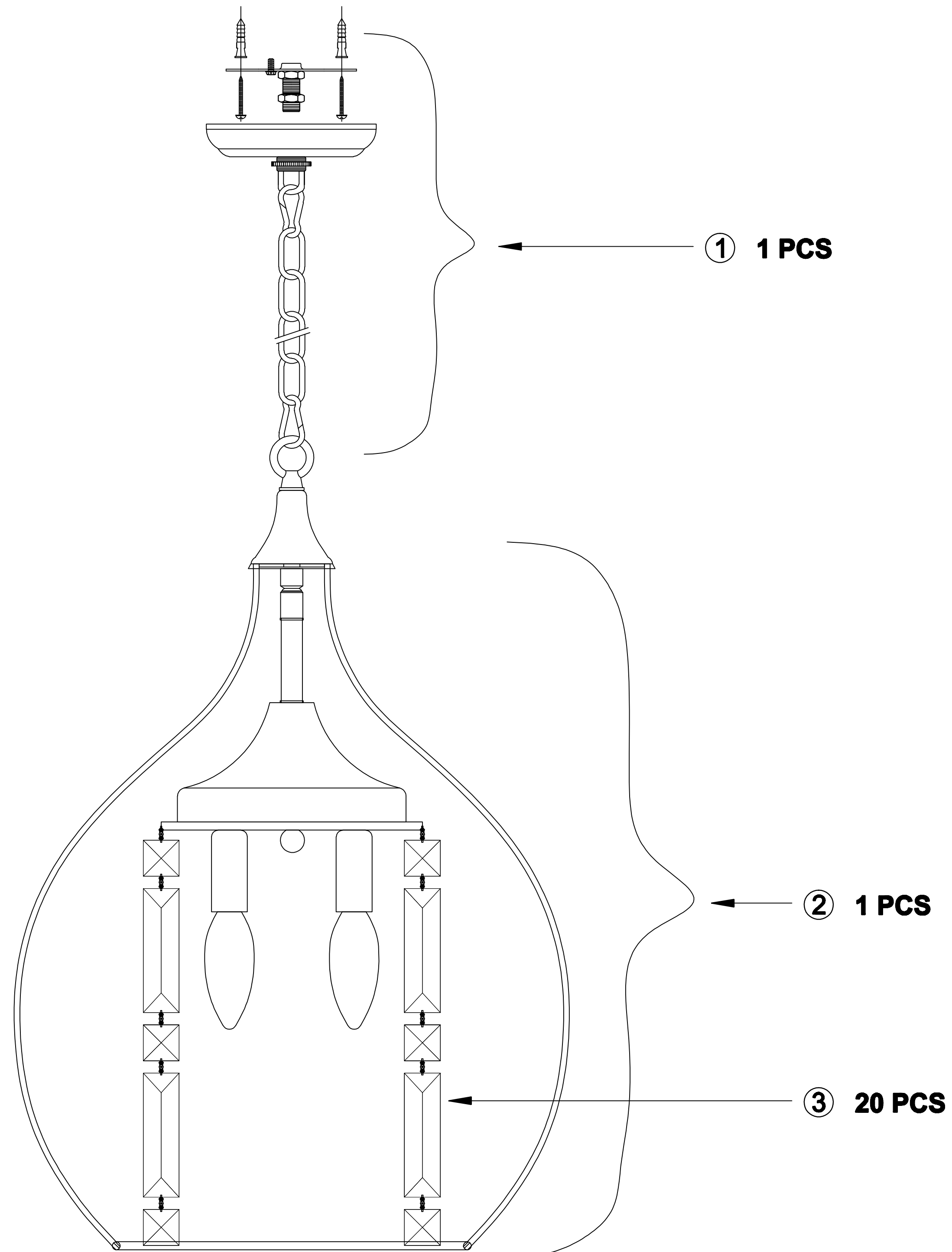

Products list

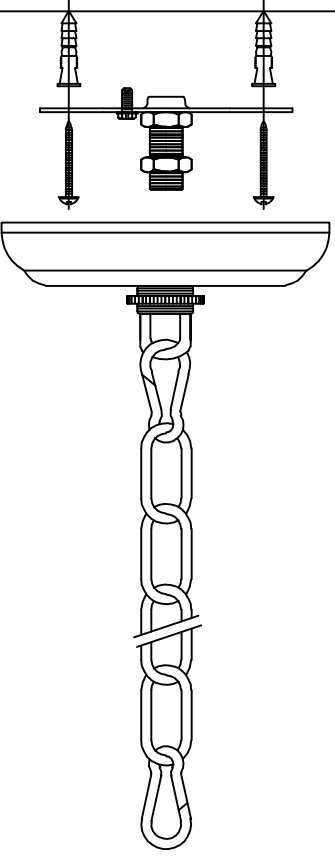
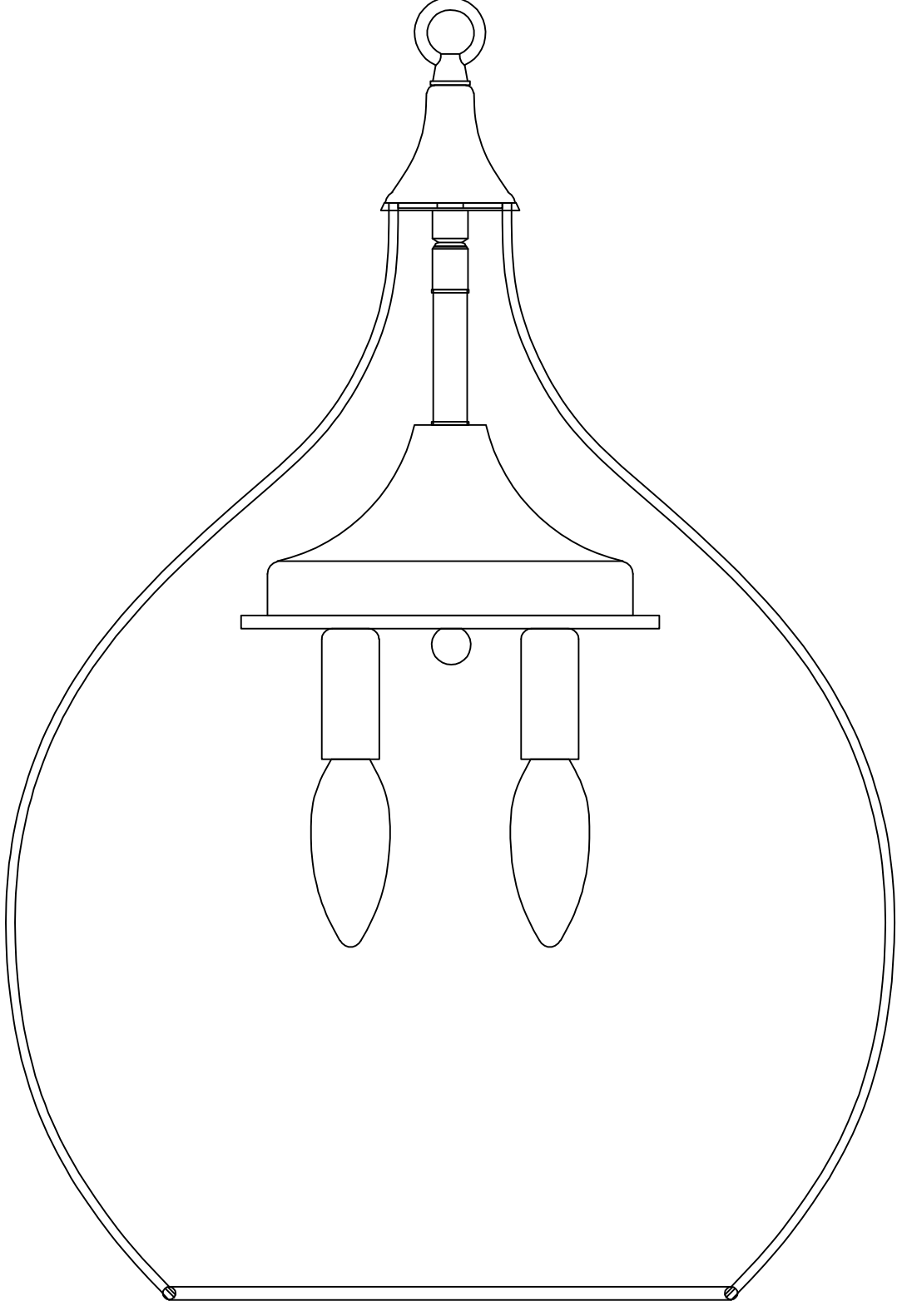
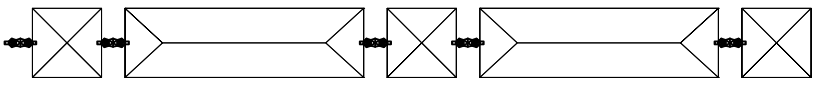
NO.	Picture	Quantity
1		1 PCS
2		1 PCS
2		20 PCS

Assembly and Installation Steps

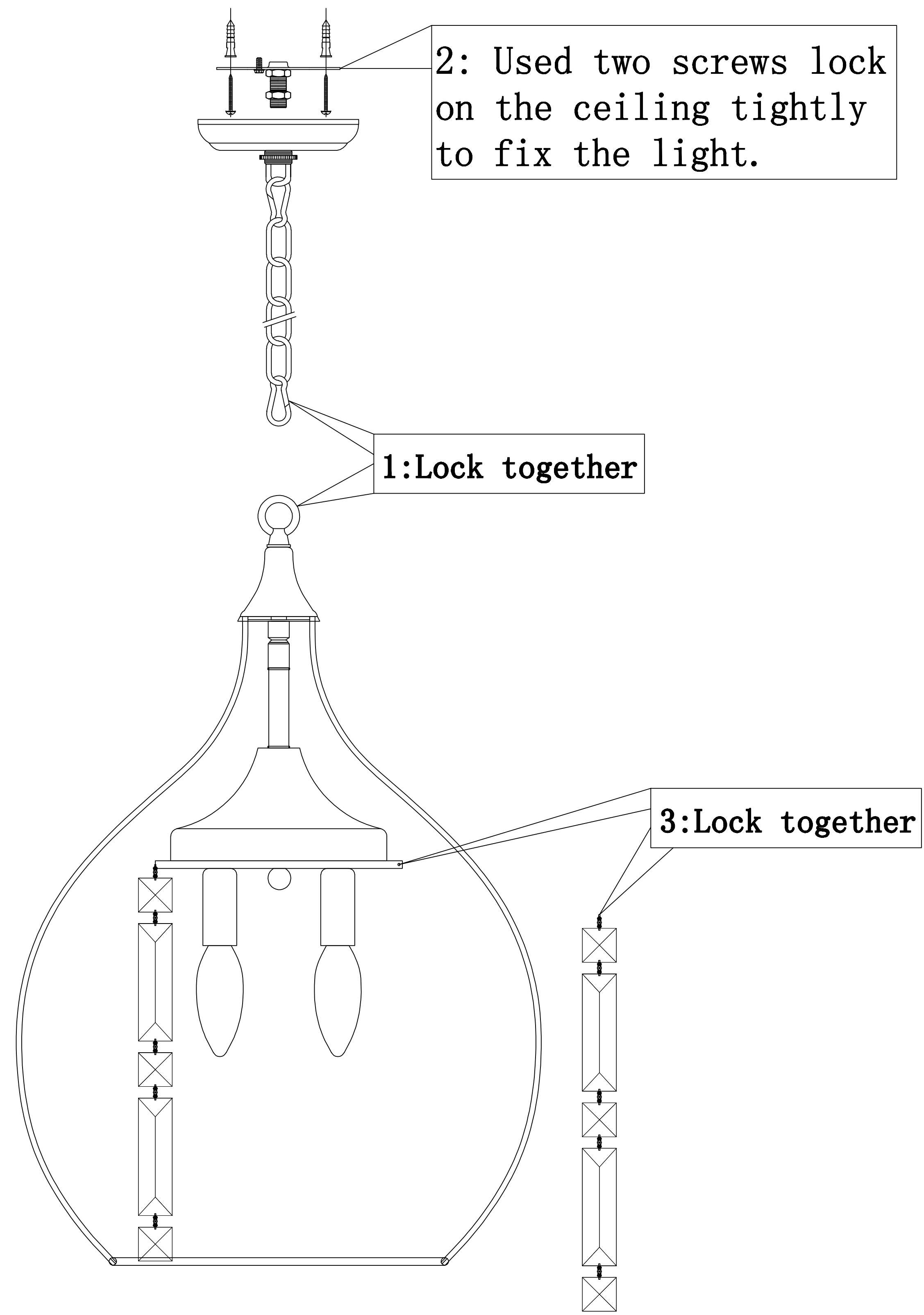

Product Size

