

WYNDHAM COLLECTION

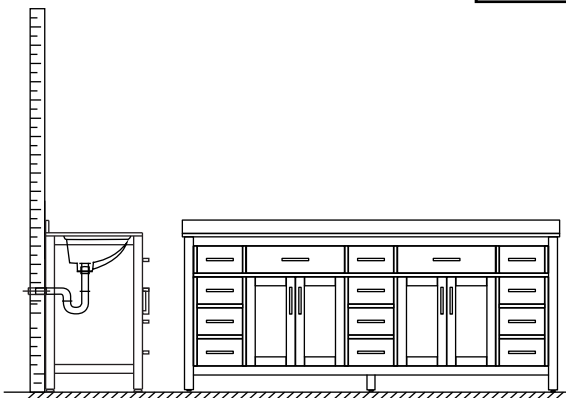

- Prior to installation please check received items against the "Packing List". Please report any missing items to your retailer immediately.
- Protect all surfaces from sharp objects, high heat sources, direct prolonged sunlight and chemical hazards.
- Professional installation recommended.
- Backsplash comes in two pieces.

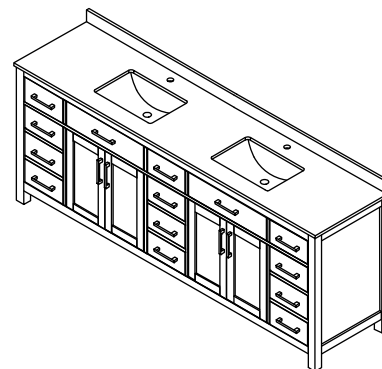

PACKING LIST

(Not all components may be included, depending upon your purchase)

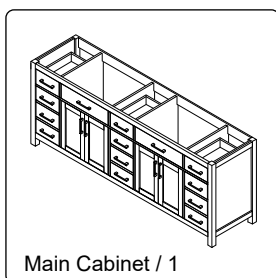
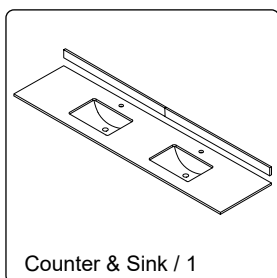

HOW TO ADJUST HINGES (if required)

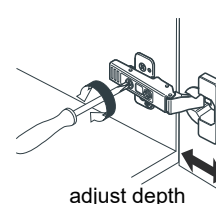
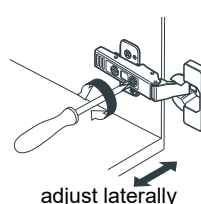
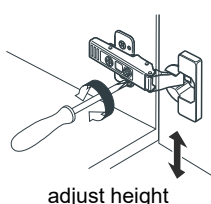
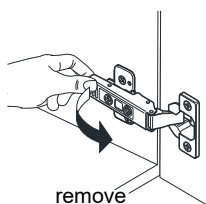
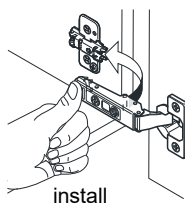

REQUIRED TOOLS NOT IN BOX



Silicone sealant

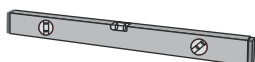

Spirit Level

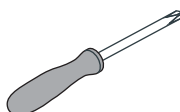

Phillips Screwdriver

WC-2424-84-DBL Installation Guide

WYNDHAM COLLECTION

INSTALLATION INSTRUCTIONS

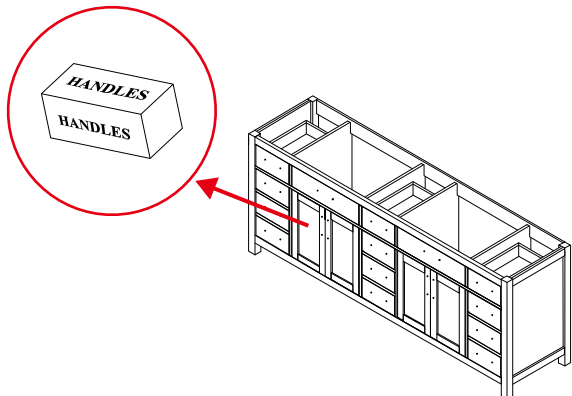

- ① The handles are safely stored for transport in a box inside of the cabinet. Look inside the vanity for the box with your handles.

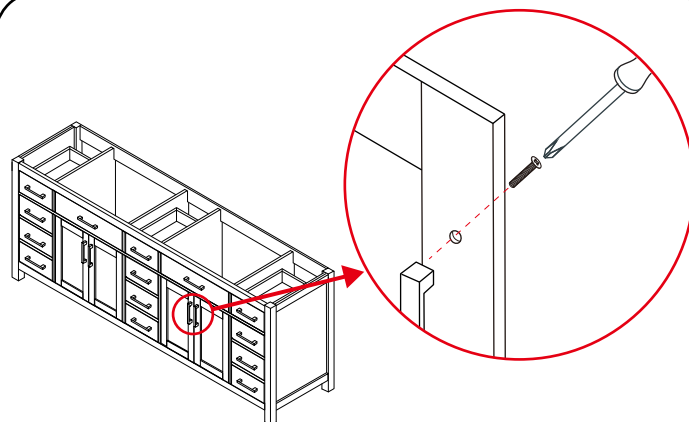

- ② Unpack the handles and install them on the vanity. Do not over tighten when attaching.

Short, for door handles

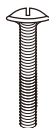

Long, for drawer handles

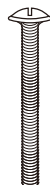

- ③ Short screws are for the door handles and long screws are for the drawer handles.

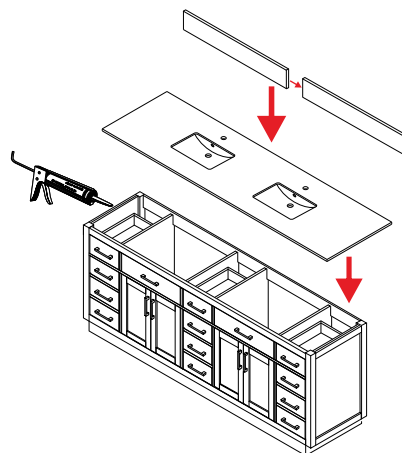

- ④ Install the counter. Seal around the top of the cabinet with clear silicone sealant. Do not over apply. Allow to dry 24 hours for proper curing.

WC-2424-84-DBL
Installation Guide