

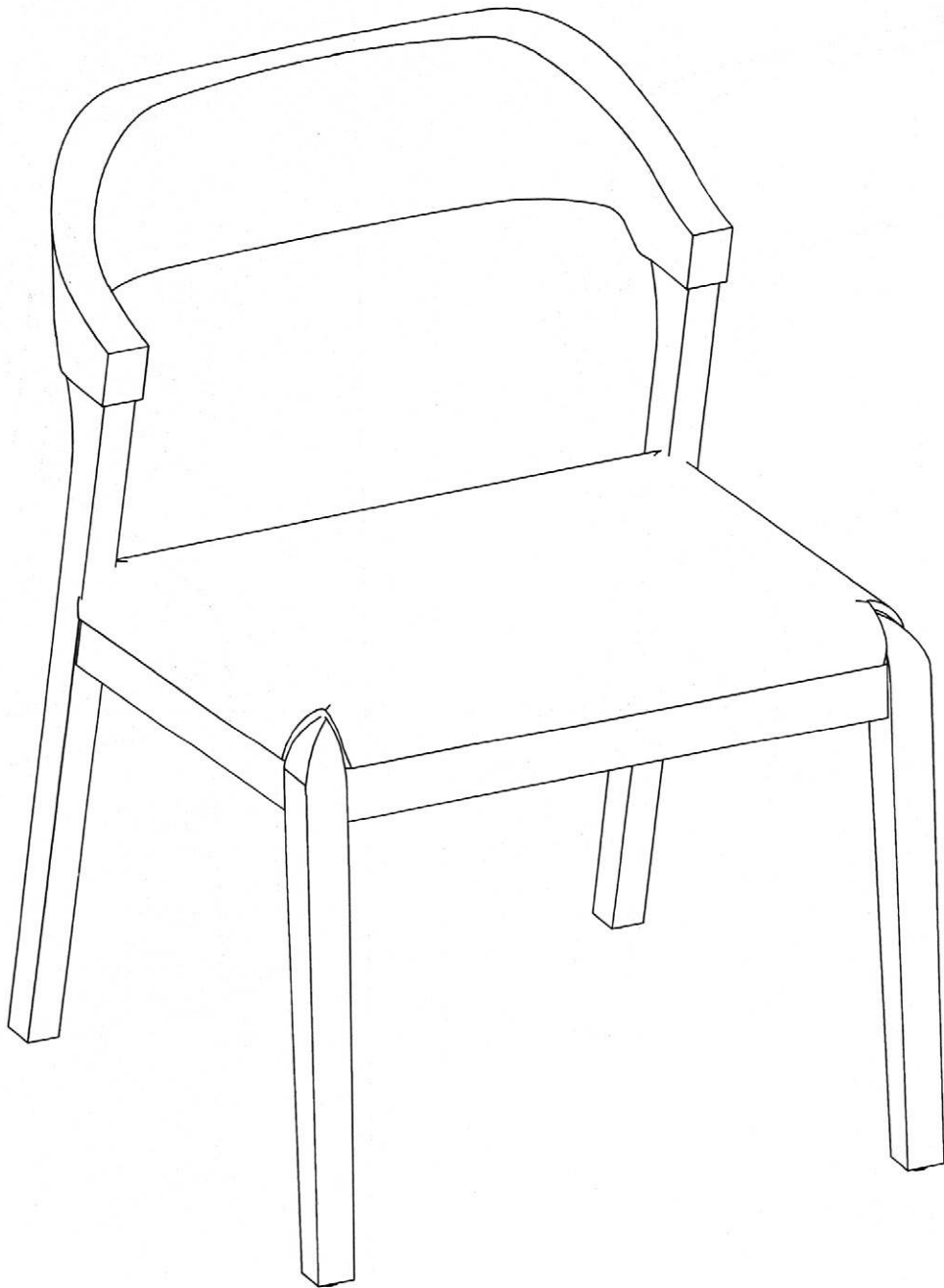

Boraam Industries

RASMUS DINING CHAIR

ASSEMBLY INSTRUCTIONS





PLEASE READ ME FIRST



- Have questions about assembling your item?



- Item or parts damaged?



- Missing a part?



- We're here to help!

 (847)949-6300 (M-F, 9am-5pm CST)



www.boraamindustries.com



customerservice@boraamindustries.com



A
M8*10
8 PCS

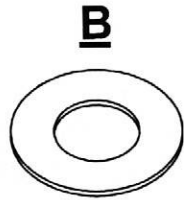

B
M8*16
8 PCS

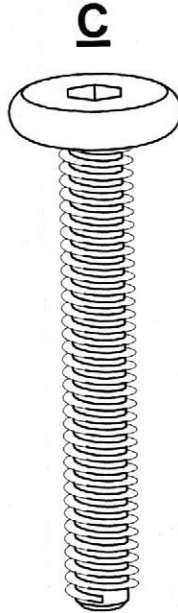

C
M8*50
2 PCS

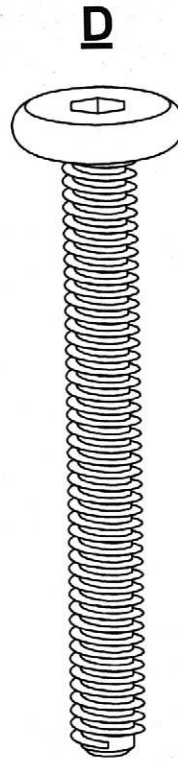

D
M8*70
8 PCS

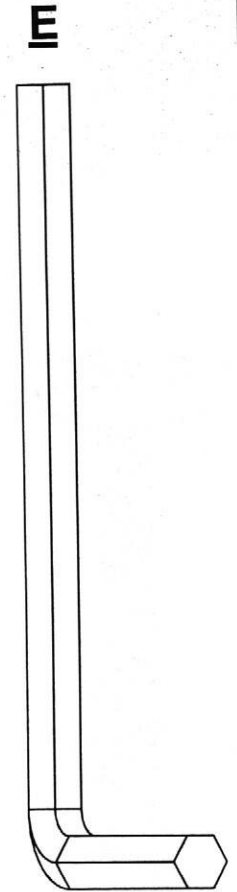

E
M4*110
1 PC

1

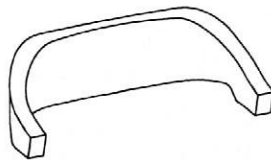

2

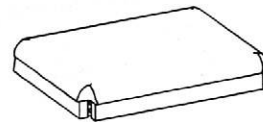

3

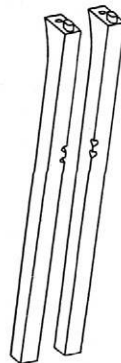

4

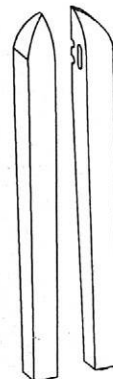

01

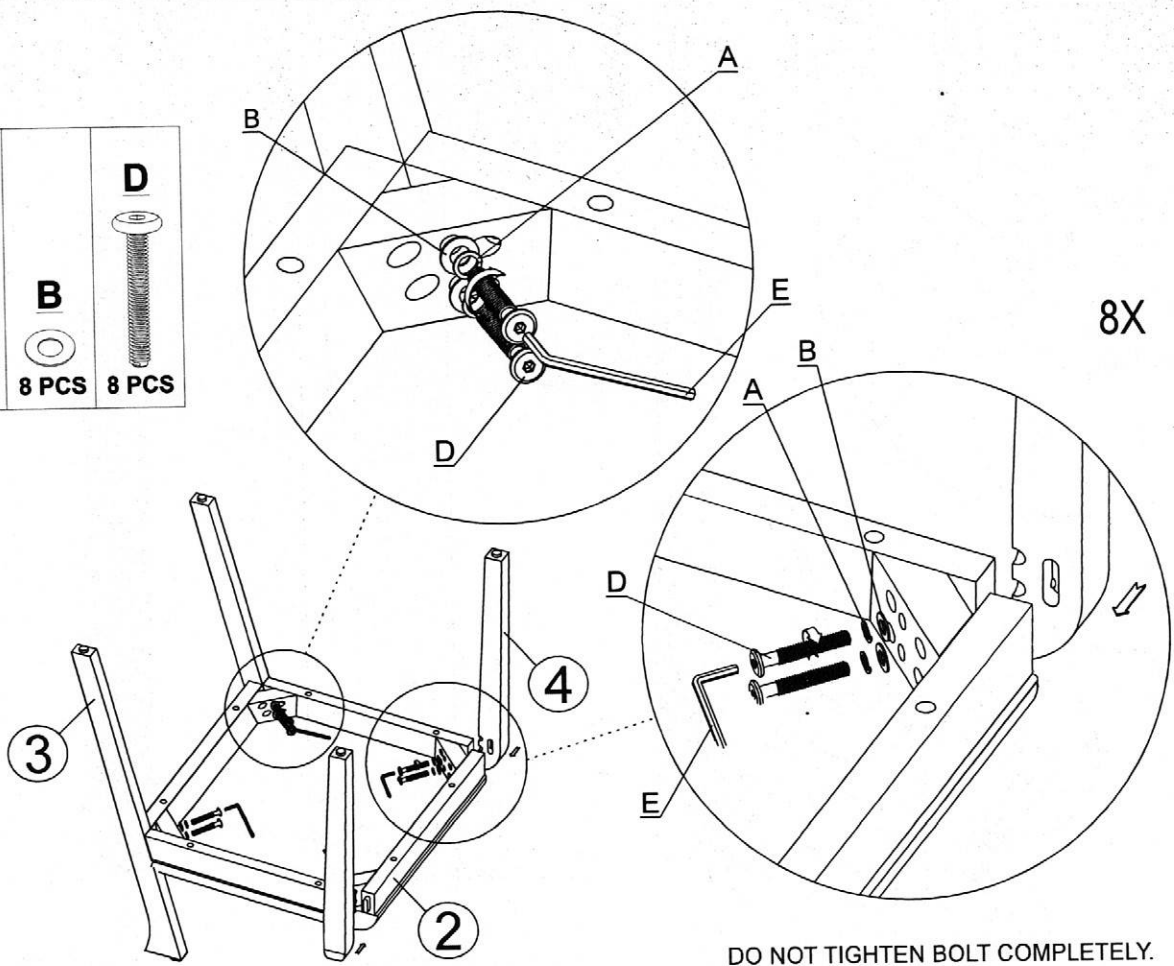
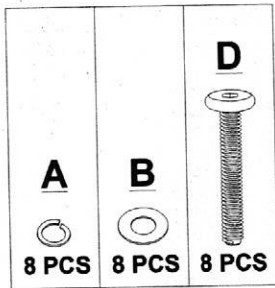

8X

DO NOT TIGHTEN BOLT COMPLETELY.

02

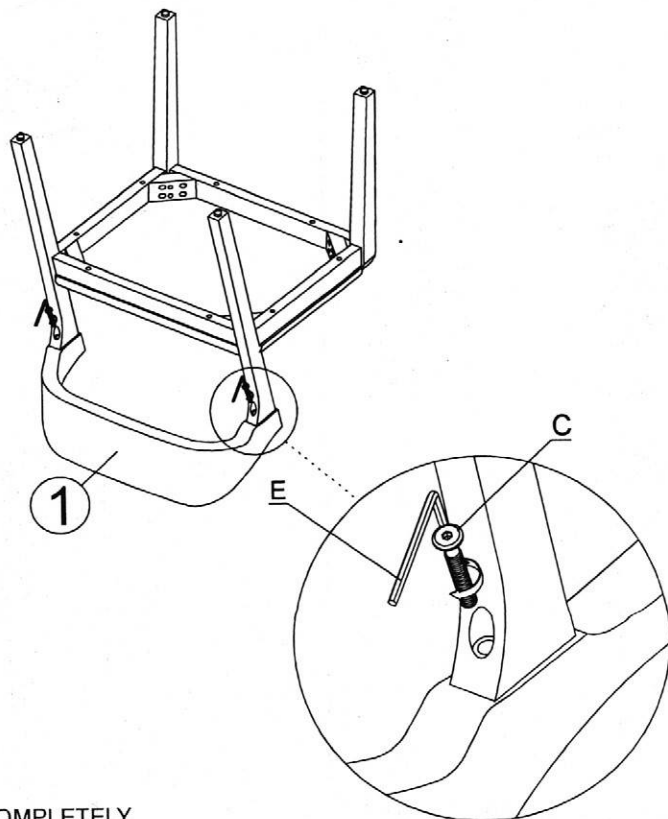

2X

TIGHTEN BOLT COMPLETELY.

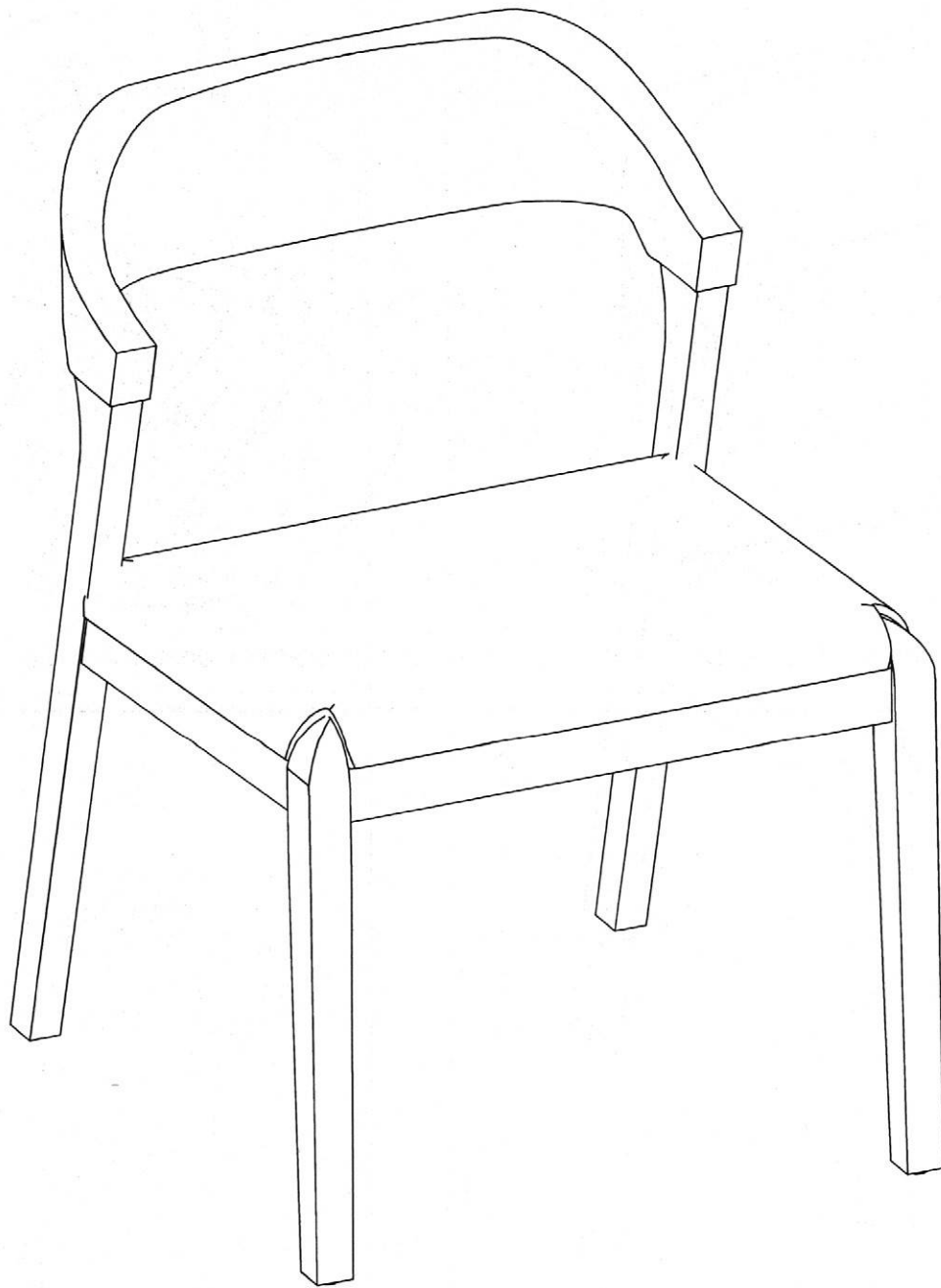

BE SURE TO CHECK ALL BOLTS ARE SECURELY
TIGHTENED PRIOR USING THIS STOOL.