

# CAMBRIDGE 43" CENTER SINK CABINET

# ARIEL

A043S



## BASE CABINET DIMENSIONS

42" W x 21.5" D x 34.5" H

## FEATURES

- Solid wood frame & plywood panels
- Dovetail drawers and joints
- Soft closing doors & drawers

## HARDWARE FINISHES

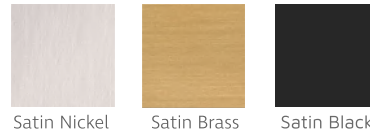

Satin Nickel Satin Brass Satin Black

## AVAILABLE COLORS

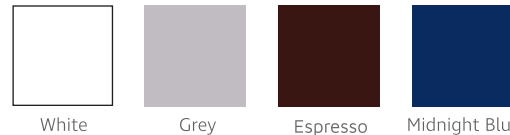

White Grey Espresso Midnight Blue

FRONT VIEW

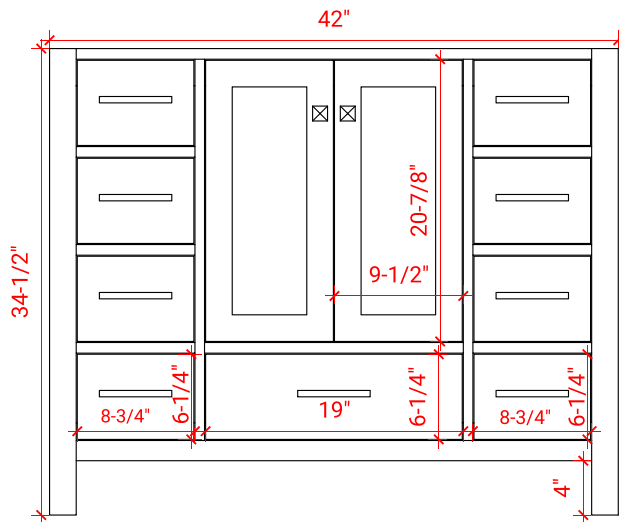

SIDE VIEW

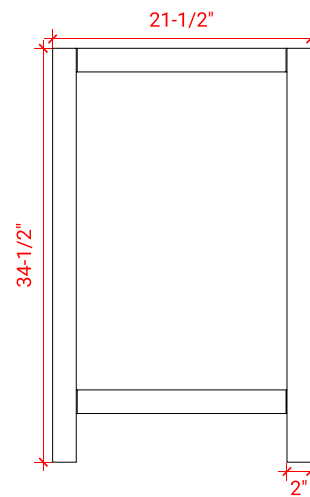

PLAN VIEW

