

Features

- Left-hand trip lever.
- Solid-brass construction for durability.
- KOHLER finishes resist corrosion and tarnish.
- For use with the K-3575 and K-3577 Wellworth Classic toilets.
- Coordinates with other products in the Wellworth Collection.



ADA CSA B651 OBC

Codes/Standards











ASME A112.18.1/CSA B125.1
ADA
ICC/ANSI A117.1
CSA B651
OBC

KOHLER® One-Year Limited Warranty

See website for detailed warranty information.

Available Colors/Finishes

Color tiles intended for reference only.

Color	Code	Description
	SN	Vibrant® Polished Nickel
	PB	Vibrant® Polished Brass
	BN	Vibrant® Brushed Nickel
	BV	Vibrant® Brushed Bronze
	2BZ	Oil-Rubbed Bronze
	0	White
	2MB	Vibrant Brushed Moderne Brass
	RGD	Vibrant Rose Gold
	TT	Titanium
	VNT	Vintage Nickel

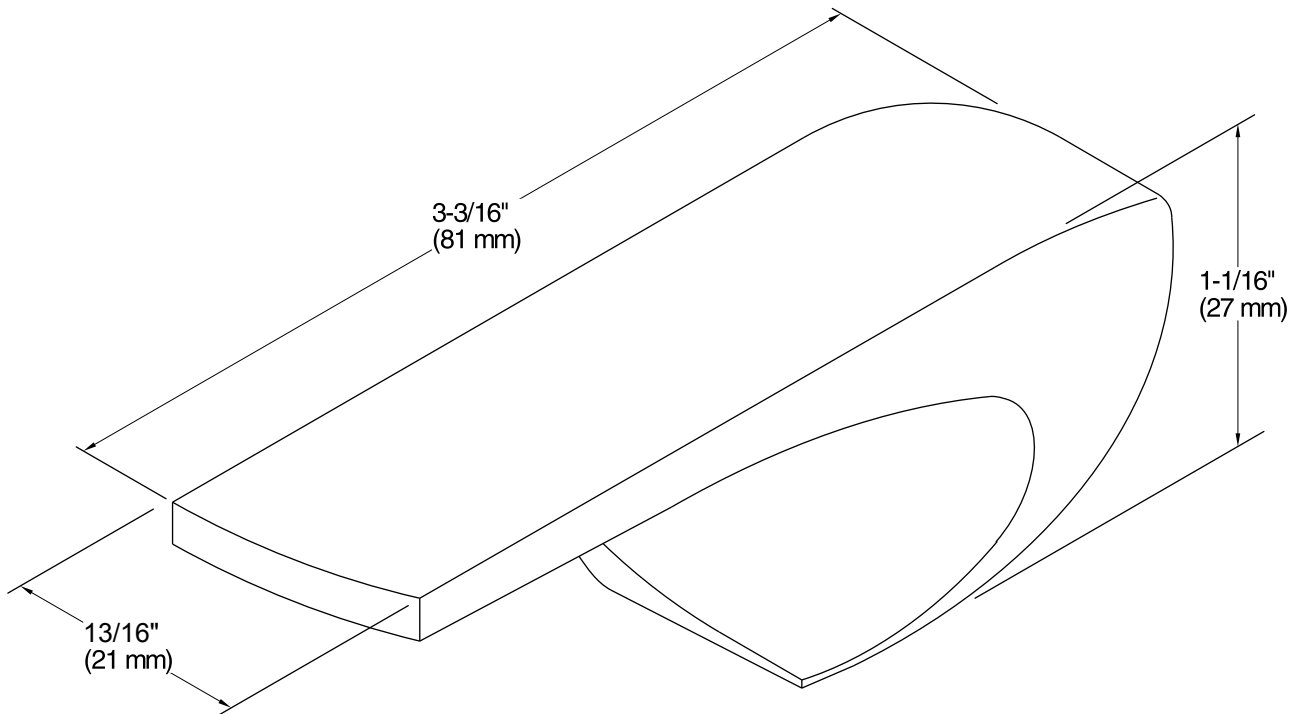

Technical Information

All product dimensions are nominal.

Notes

ADA, OBC, CSA B651 compliant when installed to the specific requirements of these regulations.