

Ambra 90F Base

Features







- Vanity Base Unit
- Available in 6 Finishes: Glossy White, Nordic Oak, Anthracite, Samara Ash, Matte White, and Matte Sand
- Free Standing Installation with Four Legs in Bright Chrome
- Two soft close drawers with hidden parcel extraction runners and organizer in upper drawer
- One soft close door with 105 degree opening capability for easy cabinet access
- Fully assembled structure and front made of engineered wood in wood finishes and high gloss lacquered
- Handle integrated in front of furniture
- Does not include vanity top or sink
- Made in Spain



SKU# | Options

- Ambra 90F NO Base | Nordic Oak
- Ambra 90F SA Base | Samara Ash
- Ambra 90F WG Base | Glossy White
- Ambra 90F AN Base | Anthracite
- Ambra 90F WM Base | Matte White
- Ambra 90F SM Base | Matte Sand

Finishes

	Nordic Oak
	Samara Ash
	Glossy White
	Anthracite
	Matte White
	Matte Sand





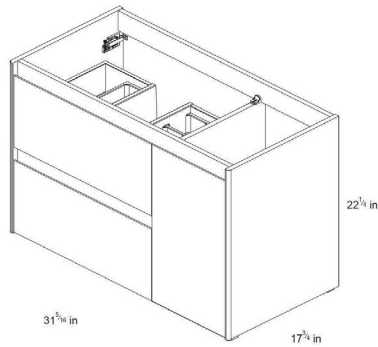

* WS Bath Collections reserves the right to revise dimensions or information on this sheet without notice

Collection Ambra	Model Ambra 90F Base	Dimensions Metric 1 inch = 2.54 cm 1 inch = 25.4 mm	 1051 Lea Drive - Collegeville, PA 19426 Tel. 215 513 9400 - Fax 610 831 0215 www.ws bathcollections.com - info@ws bathcollections.com
----------------------------	-------------------------------	--	---

Technical features



AMBRA
1 Door / 2 Drawers

-   Nordic Oak
-   Samara Ash
-   Gloss White
-   Anthracite
-   Matte Sand
-   Matte White



LEGS

-  Chrome

Technical information

STRUCTURE	MDF board in 58 in. continous wrapping in 2D/ Cyclum Process.
FRONT	MDF board in 58 in. continous wrapping in 2D/ Cyclum Process.
HANDLE	Integrated in the front of the furniture.
DRAWER	Drawers made in mokka textile poly laminate coated board with hidden parcial extraction runners with soft close system. Includes organizer in upper drawer. Lower drawer useful space (widexhighxdepth): 20 ^{1/16} x 4 ^{5/16} x 12 ^{2/4} in.
WALL HANGING BRACKET	Hidden hanging bracket of directly assembled with great resistance and depth regulations.
HINGE	105° opening, 1 ^{3/8} in. cap, easy assembly and soft close system.
LEGS	Metallic in bright chrome finish. (optional)
PIPE DEPTH	Pipe depth 2 ^{1/64} in.

Collection
Ambra

Model |
Ambra 90F Base

Dimensions Metric

1 inch = 2.54 cm
1 inch = 25.4 mm



1051 Lea Drive - Collegeville, PA 19426
Tel. 215 513 9400 - Fax 610 831 0215
www.ws bathcollections.com - info@ws bathcollections.com

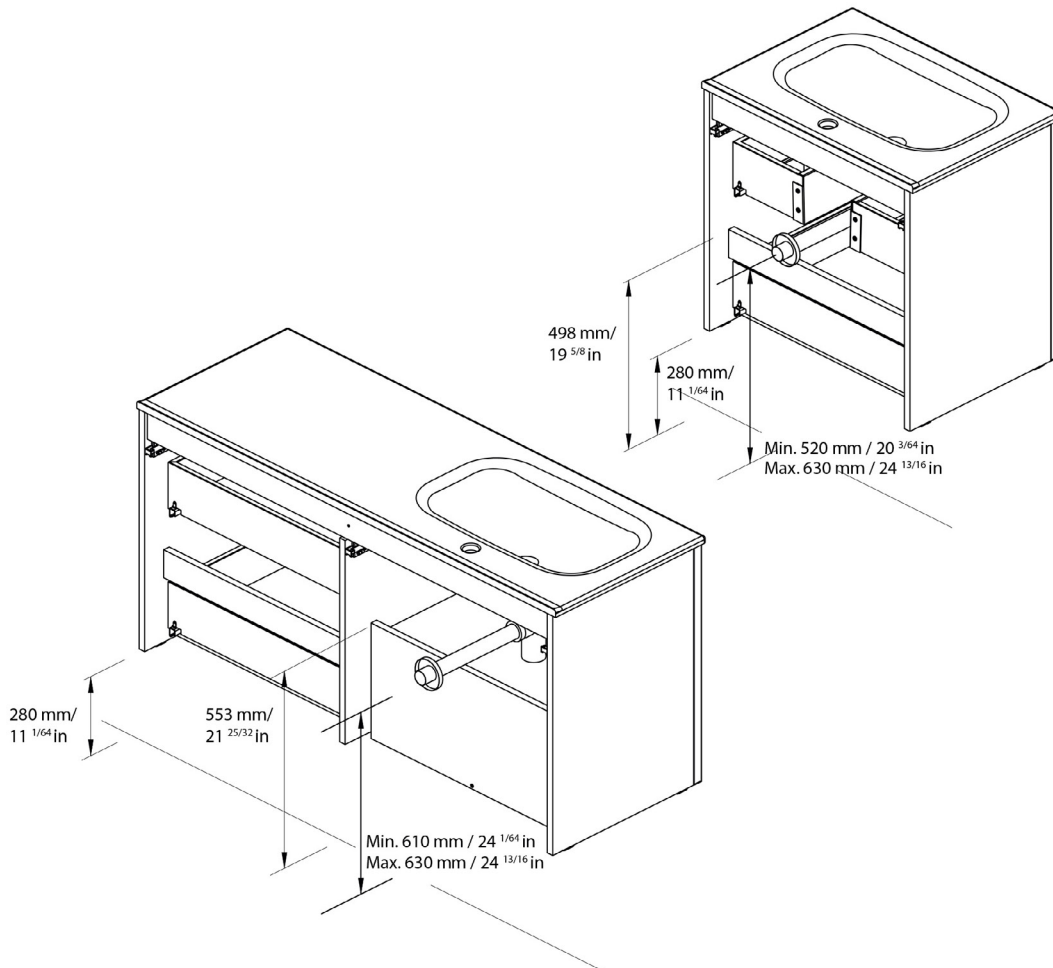

ES

EN

Las cotas indicadas en los dibujos son en función de la altura de la pata del conjunto, en caso de que el mueble vaya suspendido y esta altura no se respete, dichas cotas también variarán.

Dimensions indicated in the drawing are based on the level of the whole leg, in case of wall hanging the furniture dimensions also may vary.

Collection
Ambra

Model |
Ambra 90F Base

Dimensions Metric

1 inch = 2.54 cm
1 inch = 25.4 mm

WS®
BATH
COLLECTIONS

1051 Lea Drive - Collegeville, PA 19426
Tel. 215 513 9400 - Fax 610 831 0215

www.ws bathcollections.com - info@ws bathcollections.com