

1160009

Lexie PU Bamboo
Swivel Office Chair

Assembly Instructions

Hardware identification



A M 6*18 MM x 04



B M5 x 01

Part identification

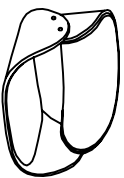

1 x 1PC



2 x 1PC

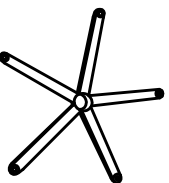

3 x 1PC

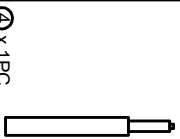

4 x 1PC

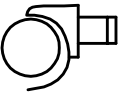

5 x 5PCS



6 x 1PC

1

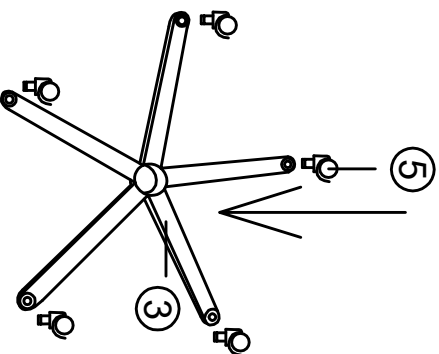

2

Warning!
please remove the
plastic cap during
assembly!

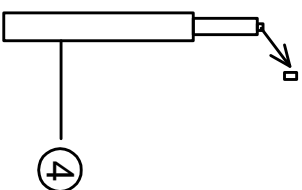

4

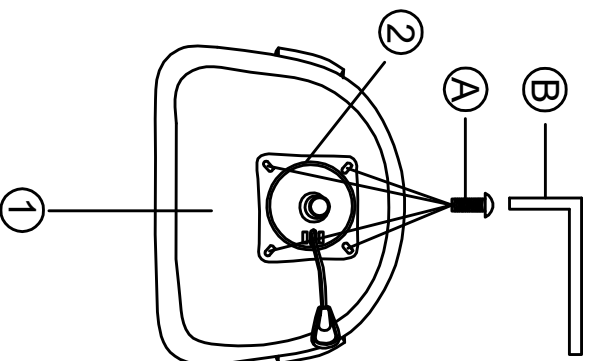

5

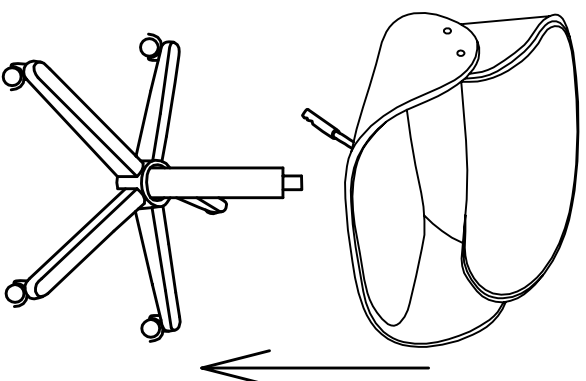

6

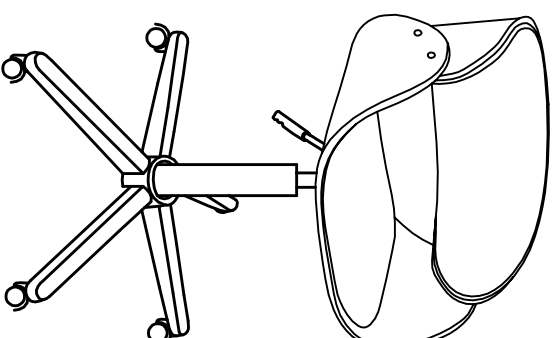

3

